

Capabilities and Activities Report, and Progress Report on Electricity and Magnetism Field at National Institute of Standards (NIS), Egypt from April, 2021 to February, 2023

Prepared by:

Prof. Dr. Rasha Sayed Attiya Mohammed

Head of Electrical Metrology Division

Section I

Capabilities and Activities Report on Electricity and Magnetism Field

at National Institute of Standards (NIS), Egypt

1. Background about NIS

1.1 NIS Mission

The mission of NIS is:

- Maintaining the national standards and disseminate them through measurement and calibration services.
- Providing training and consultation services.
- Research and development of new standards and measurement procedures.

1.2 NIS Time-Line

Metrology existed in the old Egyptian civilization. Several measurement tools were available at around 2700 B.C. For example, the Egyptian Cubit was used for the measurement of length. The book of dead that was written at around 1550 BC showed that the balance was known instrument by that time. Egyptians had a well-established metrology system since the wooden cubits were calibrated against the royal granite cubit every full moon.



During the last century, some milestones in Egyptian Metrology should be highlighted, namely:

- 1962: Egypt Signed the meter convention.
- 1963: NIS was officially founded.
- 2000: NIS signed the CIPM-MRA.

1.3 NIS Location

NIS is located at Al-Haram district in Giza around 3 km away from pyramids over an area of 150,000 m². This area allows the inclusion of 6 buildings within NIS premises.



1.4 NIS Organization Chart

NIS contains 21 laboratories in 6 divisions. One of these divisions is the electrical metrology division. The other divisions are chemical metrology, photometry & radiometry, length metrology, thermometry & ionizing radiation metrology, and mass & force metrology. The current NIS president is Prof. Dr. Noha E. Khaled.

NIS Organization Chart

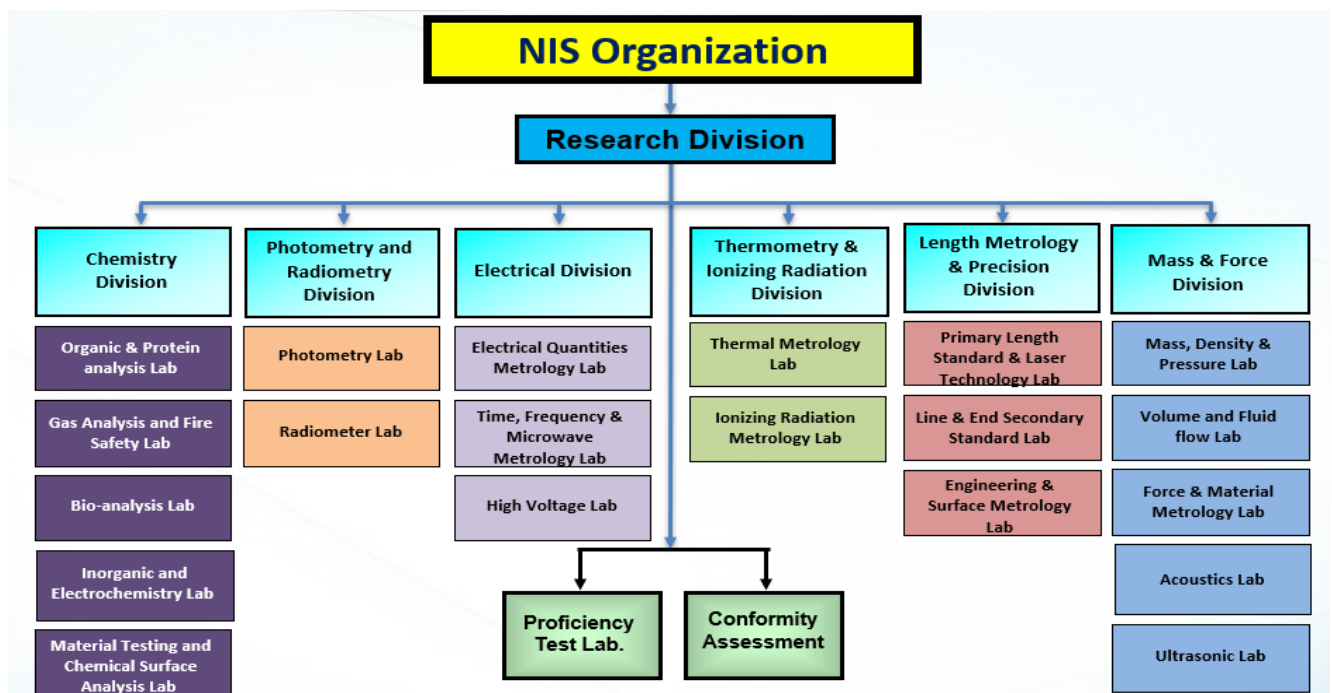
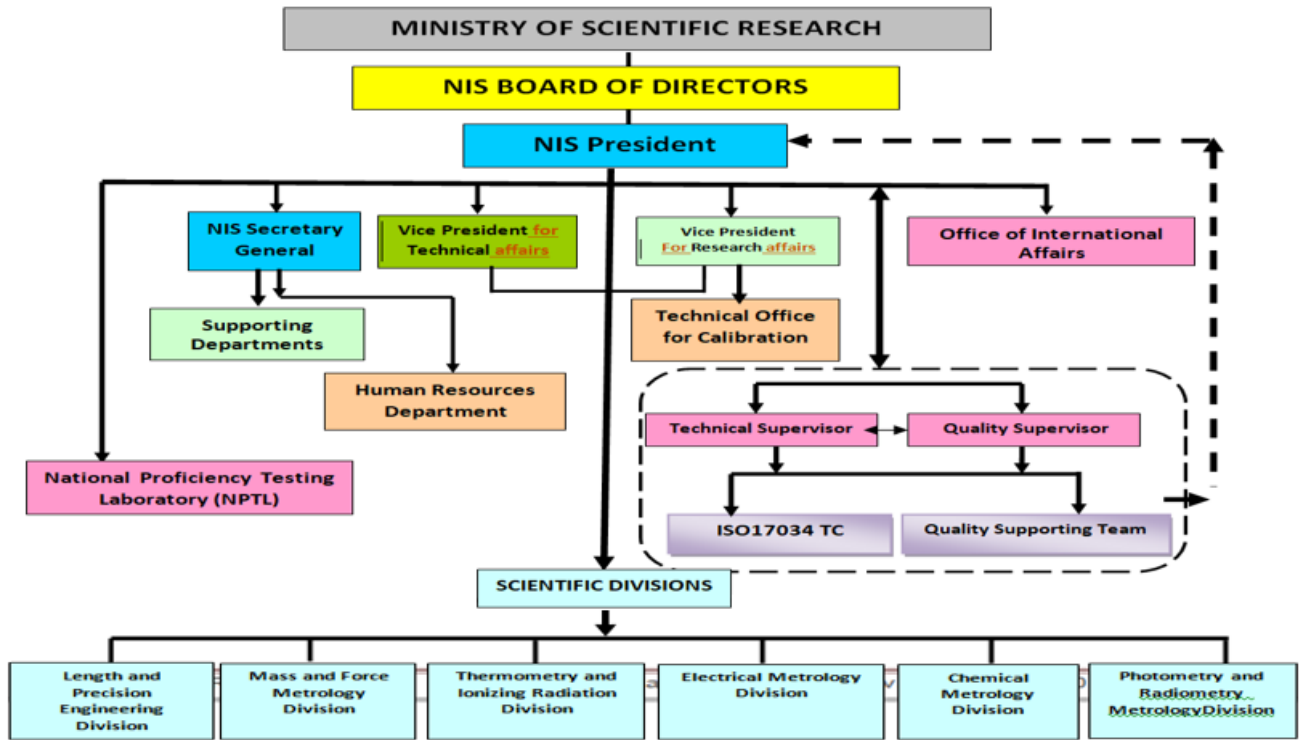

1.5 Published CMCs in the KCDB

NIS has **99 CMCs** published in the BIPM-KCDB website in different metrology areas. These CMCs include some fields such as: length, mass, pressure, time and frequency, current, resistance, voltage, radiofrequency, Power and energy, capacitance, viscosity, force, torque, hardness, chemistry, flow, ionizing radiation and acoustics. NIS currently paying attention to the importance of the international recognition. Therefore, this number is expected to be rapidly increasing during the current decade.

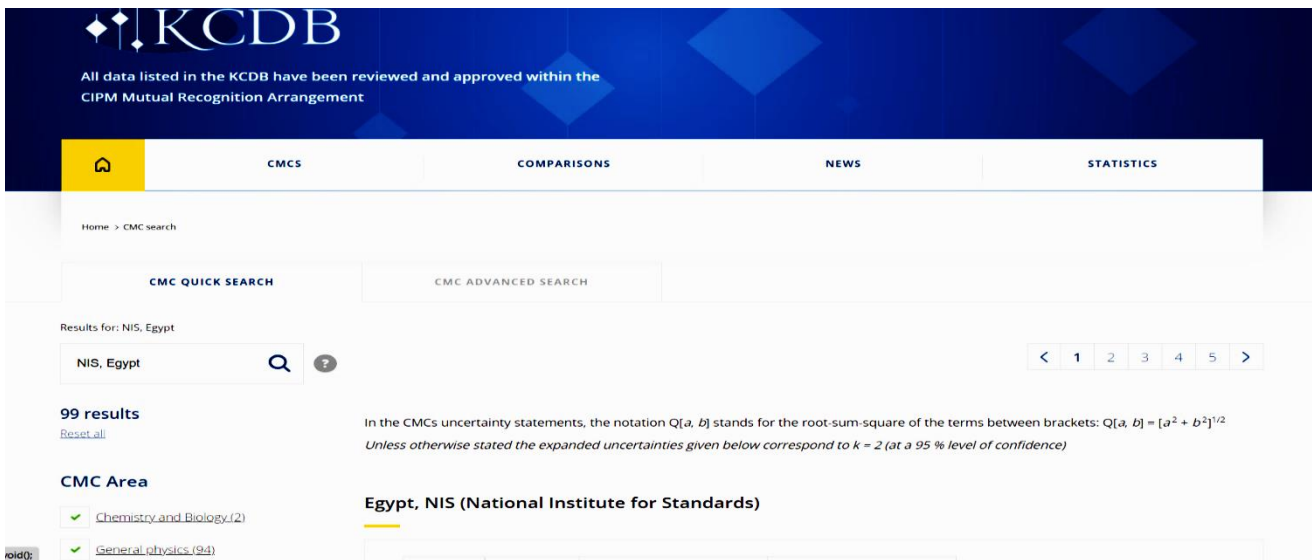

The screenshot shows the KCDB website interface. At the top, it says "All data listed in the KCDB have been reviewed and approved within the CIPM Mutual Recognition Arrangement". Below this is a navigation bar with "CMCS", "COMPARISONS", "NEWS", and "STATISTICS". The main content area shows search results for "NIS, Egypt" with 99 results. A note explains the notation $Q[a, b] = [a^2 + b^2]^{1/2}$ used in uncertainty statements. The results are categorized by "CMC Area" with "Chemistry and Biology (2)" and "General physics (94)".

2. Electrical Metrology Division Structure

Electrical Metrology division at NIS consists of 3 laboratories. They are Electrical Quantities Metrology Laboratory, Time, Frequency, and Microwave Laboratory, and High Voltage Laboratory. There are 21 researchers, 8 assistant researchers, 5 specialists and 6 technicians working in electrical metrology division which is led by Prof. Dr. Rasha Sayed. Each laboratory in electrical metrology division is specialized in certain topics and led by its own head. The areas of interest of the three departments are:

2.1 Electrical Quantities Metrology Laboratory - Head: Prof. Dr. Nadia Nassif

- DC Voltage and Current Calibrations.
- Electrical DC Resistance Calibrations.
- Electrical Impedance Calibrations.
- AC/DC Transfer Standards Calibrations.

2.2 Time, Frequency, and Microwave Laboratory - Head: Dr. Mohamed El-Hawary **(Microwave Activity)**

- Scattering Parameters Measurement (Frequency: 10 MHz to 40 GHz).
- RF Power Measurements (Frequency: DC to 40 GHz).
- Power Sensors Frequency Calibration.
- Power Meters Frequency Calibration.
- Spectrum Harmonics Measurement (Frequency: 9 kHz to 30 GHz).
- Transponder Tester Calibration.
- Electric and Magnetic Fields Strength Measurements.

2.3 High Voltage Laboratory - Head: Prof. Dr. Mamdouh Halawa

- High Voltage and Current Calibrations.
- Power and Energy Calibrations.
- Electrical Safety Testers Calibration.
- EMC Testing.
- Other Testing such as Performing approval type test on electricity energy meters for all types and accuracy.

3. Capabilities of Electrical Metrology Division at NIS

The measurement and calibration activities at electrical metrology division are summarized as following:

3.1 Electrical Quantities Metrology Laboratory

The laboratory is responsible for maintaining and disseminating the national electrical standards for the quantities of DC voltage and current, AC voltage and current, resistance, capacitance, and inductance. Calibration of the standards and electrical equipment of scientific and industrial laboratories are performed through the traceability to the SI units.

3.1.1 DC Voltage and Current Calibrations

Since year 2009, the laboratory had the 10 V Josephson Array Voltage Standard (JAVS) that represents the SI unit of voltage, as national standard of DC voltage. The introduced expanded uncertainty is less than or equal to 0.2 ppm. The unit of voltage is also maintained via a bank of 8 Zener diode reference standards as secondary standards with 1.018 V, and 10 V outputs.



The laboratory is capable of calibrating DC instruments using either JAVS or other suitable reference standards such as Zener reference standard, DC standard resistors, multi-function calibrators, and reference multimeters. Zener reference standards are calibrated using JAVS with expanded uncertainty from 0.03 ppm to 0.2 ppm. The laboratory has capabilities in calibrating the different DC instruments for sourcing and measuring DC voltage up to 1000 V with expanded uncertainty from

0.13 μV to 44 mV and DC current up to 20 A with expanded uncertainty from 2 nA to 7.9 mA. The laboratory has several CMCs published in BIPM-KCDB website for some of these scopes.

3.1.2 Electrical DC Resistance Calibrations

The unit of resistance is maintained at NIS by the mean of five "One Ohm" Thomas type standard resistors. It also has two 10 k Ω ESI standard resistors, two 100 Ω IET standard resistors, Hamon transfer standards from 1 Ω /step to 10 M Ω /step, and Fluke standard resistors from 1 Ω to 10 M Ω . Moreover, the laboratory has highly accurate automatic resistance bridge MI model 6010C with range extender and DC power supply for resistors from 1 m Ω to 10 k Ω . For resistance standards higher than 10 k Ω to 100 M Ω , a potentiometric bridge has been established at the laboratory. The dc resistance standards calibrations capabilities are from 1 m Ω to 100 M Ω with expanded uncertainty from 0.3 ppm to 761 ppm. The laboratory has CMCs published in BIPM-KCDB website for some of these ranges and some other ranges are now in the inter-review process for mutual international recognition.



3.1.3 Electrical Impedance Calibrations

The unit of capacitance is maintained by some types of capacitance standards, such as two sets of AH Fused Silica capacitance standards, and general radio and IET air capacitance standards. The unit of inductance is maintained by different types of inductance standards. Highly accurate capacitance measurements are carried out using ultra precision capacitance bridge with (option E) which is the first copy of this version in the world. This bridge has been designed specially to meet the critical requirements of the calibration and research laboratories. The laboratory also has a precise automatic LCR meter, two General Radio bridges for capacitance and inductance measurements, and new impedance analyzer- 120 MHz.

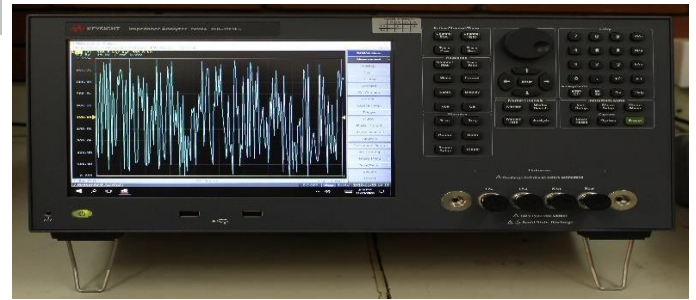

The laboratory is capable to calibrate instruments, with the capabilities presented in the following table:

Discipline	Range	Expanded Uncertainty (k=2)
AH Fused Silica capacitance standards	1 pF, 10 pF, 100 pF	≤ 0.7 ppm
General Radio capacitance standards	1 nF - 10 μ F	3 ppm - 100 ppm
Inductance Standards	10 μ H - 10 H	3 nH - 8 mH
Highly accurate capacitance measurement	0.8 aF - 1.5 μ F	> 5 ppm
Accurate capacitance measurement	1 pF - 10 μ F	1 pF - 10 μ F
Accurate inductance measurement	10 μ H - 10 H	3.2 nH- 5.6 mH

The laboratory has CMC published in BIPM-KCDB website in this activity.

3.1.4 AC/DC Transfer Standards Calibrations

AC voltage and current are maintained in the laboratory by multi-junction and single-junction thermal converters connected with multipliers or current shunt resistors to cover the AC voltage up to 1000 V and AC current up to 20 A.



The laboratory is capable to calibrate AC sources, and AC/DC transfer standards using thermal voltage converters (TVCs) from 0.3 V to 1000 V at frequencies from 10 Hz to 1 MHz and Micro-potentiometers (μ pots) for ranges from 2 mV to 200 mV at frequency range from 10 Hz to 100 kHz with expanded uncertainty from 3 ppm to 150 ppm, and thermal current converters (TCCs) up to 20 A at 10 Hz to 10 kHz with expanded uncertainty from 3 ppm to 25 ppm. Other AC instruments for sourcing and measuring AC voltage from 1 mV to 1000 V at 10 Hz to 1 MHz are calibrated with expanded uncertainty from 3.7 μ V to 590 mV, and AC current from 100 μ A to 20 A at 10 Hz to 10 kHz with expanded uncertainty from 10 nA to 10 mA. The laboratory has several CMCs published in BIPM-KCDB website in this activity.

3.2 Time, Frequency, and Microwave Laboratory (Microwave Activity):

The laboratory in the microwave activity is realizing and maintaining the national primary standard of high frequency power using Microcalorimeter in the frequency range from 10 MHz to 18 GHz with expanded uncertainty from 3.2×10^{-3} to 6.1×10^{-3} (dimensionless).



3.2.1 Scattering Parameters Measurement (Frequency: 10 MHz to 40 GHz)

The laboratory calibrates the commercial RF attenuators (N-Type, K-type, BNC, SMA connectors), adaptors, isolators, directional coupler, directional bridges, pulse limiters, cables, RF filters, power sensors, power splitters, antennas, and site master calibrators using Vector Network Analyzer (VNA) and N-Type calibration kit. The calibrated parameters are voltage standing wave ratio (VSWR), Reflection coefficient (S11), and Transmission coefficient (S21, S12). The introduced expanded uncertainty of transmission coefficient is from 7.4×10^{-2} to 0.15 dB at 60 dB and the expanded uncertainty of reflection coefficient magnitude (0 to 1) is from 6.0×10^{-3} to 2.8×10^{-2} (dimensionless). Some of these CMCs published in BIPM-KCDB website.

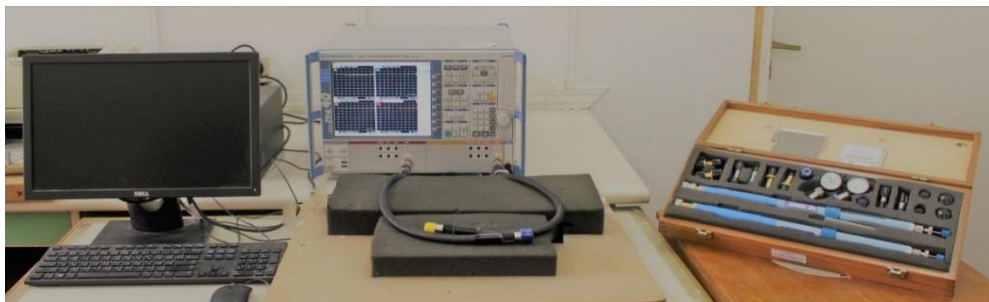

3.2.2 RF Power Measurements (Frequency: DC to 40 GHz)

The laboratory calibrates the following:

- Signal generators using power meter that covers the power range from 1 μ W to 100 mW (-30 dBm to +20 dBm) with an expanded uncertainty from 5.9×10^{-03} to 7.4×10^{-02} dBm.
- RF sources by using spectrum analyzer that covers frequency range from 9 kHz to 30 GHz and power range up to 1000 mW (+30 dBm) with an expanded uncertainty up to 1.9×10^{-02} dBm.
- RF receivers (like: Spectrum analyzer, TV receivers, power meter) using signal generator that covers a frequency range from 100 kHz to 40 GHz and power range up to 501 mW (+27 dBm) with expanded uncertainty up to 2.2×10^{-02} dBm.



3.2.3 Power Sensors Frequency Calibration:

The laboratory has the capabilities to calibrate the power sensors in two stages to obtain the Calibration Factor (CF) from 0.8000 to 1.0000 at frequency range from 10 MHz to 18 GHz and power range from 0.1 mW to 10 mW (-10 dBm to 10 dBm) with expanded uncertainty from 6.2×10^{-03} to 8.6×10^{-03} (dimensionless). The two stages are as following:

- Power calibration using a signal generator and power meter (standard power sensor).
- Reflection coefficient using VNA and N-Type calibration kit.

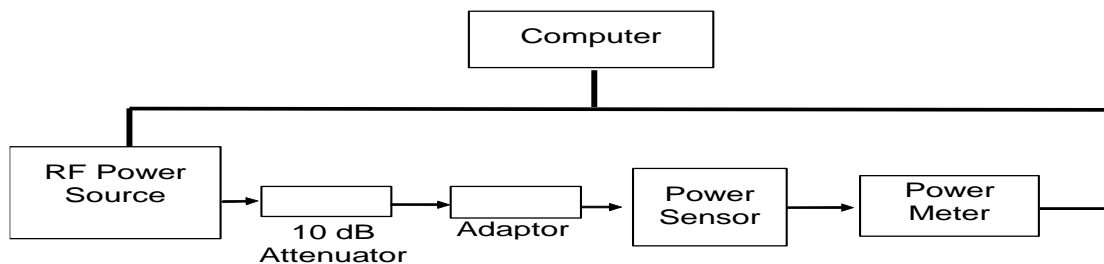

3.2.4 Power Meters Frequency Calibration:

The laboratory calibrates power meters to obtain their power level using a signal generator that covers a frequency range from 100 kHz to 40 GHz and power range up to 501 mW (+27 dBm) with expanded uncertainty up to 2.2×10^{-02} dBm.



3.2.5 Spectrum Harmonics Measurement (Frequency: 9 kHz to 30 GHz)

The laboratory measures phases for harmonic and distortion measurement processes for many devices such as atomic time and frequency standard, quartz frequency standard, synthesized signal generators, and synthesized frequency generators using spectrum analyzer. The measured parameter is dBc in the range: 0.00 dBc to - 90 dBc that covers frequency range from 9 kHz to 30 GHz and power range up to 1000 mW (+30 dBm) with expanded uncertainty 7.1×10^{-01} dBc.

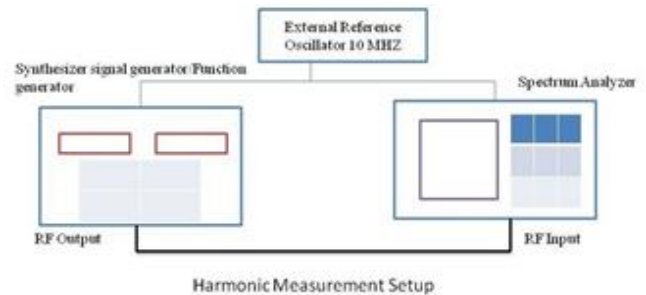
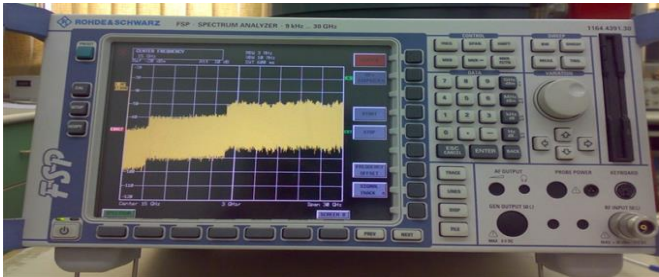

3.2.6 Transponder Tester Calibration

The laboratory has the capabilities to calibrate the transponder testers using spectrum analyzer to measure the frequency range from 9 kHz to 30 GHz and power range up to 1000 mW (+30 dBm), and vector network analyzer (VNA) with N-Type calibration kit to measure VSWR on antenna port and on RF I/O port at frequency range from 10 MHz to 40 GHz with expanded uncertainties from 6.0×10^{-03} to 2.8×10^{-02} (dimensionless).

3.2.7 Electric and Magnetic Fields Strength Measurements

The laboratory measures the electric and magnetic fields from any electrical instruments that radiate electromagnetic waves such as antennas, mobile stations using a broadband field strength meter that cover a frequency range from DC to 40 GHz using the probes. The laboratory has 3 probes differs in frequency and electromagnetic strength ranges as following:

- **Probe 1:** Frequency range (1 Hz – 400 kHz), measurement range E-field: 1 V/m to 100 kV/m, H-field: 50 nT to 10 mT.
- **Probe 2:** Frequency range (100 kHz - 3 GHz), measurement range E-field: 0.2 V/m to 20 V/m (RMS).
- **Probe 3:** Frequency range (1 MHz - 40 GHz), measurement range E-field: 1 V/m to 55 V/m (RMS).



3.3 High Voltage Laboratory

The main goal of the Laboratory is achieving traceability to SI unit in measuring and sourcing AC and DC high voltage and high current instruments. The laboratory also achieves traceability to SI unit in measuring and sourcing power and energy instruments based on the national primary standard of electrical power and energy. The calibrations are done according to the international standards.

3.3.1 High Voltage Calibrations

The laboratory performs several calibrations in high voltage activity such as calibration of AC/DC HV sources for AC voltage ranges up to 400 kV at 50 Hz and DC voltage ranges up to 200 kV, calibration of AC/DC HV meters in AC & DC voltages up to 200 kV with introduced expanded uncertainty from 1.3% to 1.5% in AC voltage calibrations and from 0.7% to 1.2% in DC voltage calibrations. These calibrations are done according to the international standard IEC 60060-1/2:2010. Calibration of voltage transformers turns ratio up to 400 kV at 50 Hz with expanded uncertainty equal to 0.03%, calibration of partial discharge calibrators up to 2000 pC with expanded uncertainty equal 3%, Oil testers calibration up to 100 kV at 50 Hz with expanded uncertainty equal to 0.15%, calibration of HV impulse generators up to 500 kV peak with expanded uncertainty 0.65%, and calibration of HV insulation testers up to 611 GΩ at 5000 V with expanded uncertainty equal to 0.1% are also performed. The laboratory is ILAC accredited up to 100 kV in AC and DC voltage calibrations.

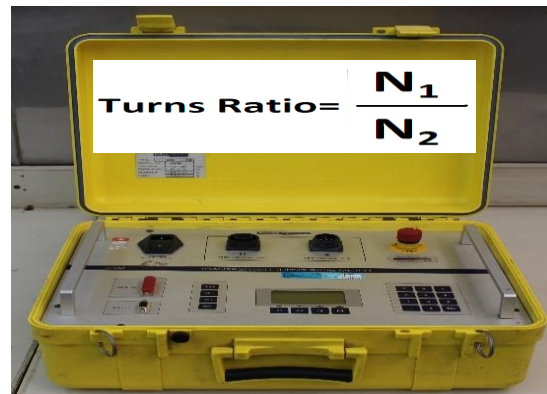

3.3.2 High Current Calibrations

The laboratory performs several calibrations in high current activity such as AC current sources and meters calibrations up to 5 kA at 50 Hz and DC currents up to 2 kA, current transformers calibration up to 5 kA at 50 Hz, calibration of clamp meters, calibration of primary and secondary injection current units, calibration of load bank current, and calibration of DC battery current. The introduced expanded uncertainty is 0.3 % in AC and DC high current calibrations.



3.3.3 Power and Energy Calibrations

The laboratory performs power and energy calibrations and measurements using reference standard with accuracy up to 30 ppm in voltage and 90 ppm in current and 85 ppm in power and energy. Power and energy instruments can be calibrated up to 300 V and 100/1000/5000 A at any power factor. The laboratory performs calibrations of power meters and analyzers, energy standard meters, power factor meters, and power sources. The introduced expanded uncertainty is up to 0.02%. Some of these calibrations are done according to the international standard ES 1021:2010. The laboratory is accredited and has CMCs published in BIPM-KCDB website for some power and energy measurements.



3.3.4 Electrical Safety Testers Calibration

The laboratory calibrates electrical safety testers that used for testing of household appliances. The calibration of AC voltage, insulation resistance, earth resistance, AC power, and leakage current measurements are performed with the laboratory capabilities in these quantities.



3.3.5 EMC Testing

It is the branch of electrical engineering concerned with the unplanned generation, propagation and reception of electromagnetic energy which may cause unwanted effects such as electromagnetic interference (EMI) or even physical damage in operational equipment. Regarding this issue, the laboratory performs some tests such as surge immunity test, fast transient burst test, magnetic field test, conducted emission test, conducted immunity test, radiated emission test, and radiated immunity test.

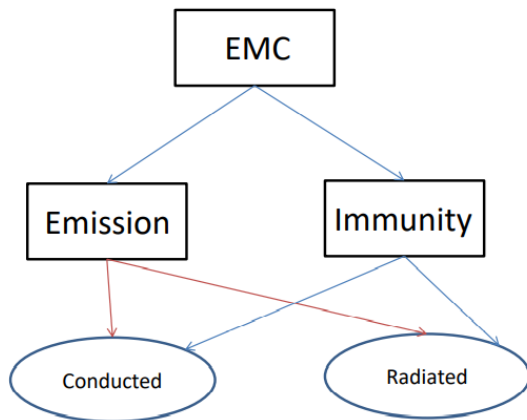

3.3.6 Other Testing

The laboratory performs other testing such as the electrical approval type tests on electricity energy meters for all types and accuracy. Testing of electrical meters is carried out according to international standards such as IEC 62052-11, IEC 62053-21, IEC 62053-22, IEC 62053-23, IEC 62053-24, EN 50470-1, and EN 50470-3. Some of these tests are ILAC accredited.



4. Research Activities

In the field of electricity and magnetism, NIS has published more than **74 publications** in scientific journals indexed in SCOPUS during the period from 2005 to 2022. Abstracts of some of these papers published recently as following:

4.1 Establishment of New Automated Multi Range Thermal Current Converter

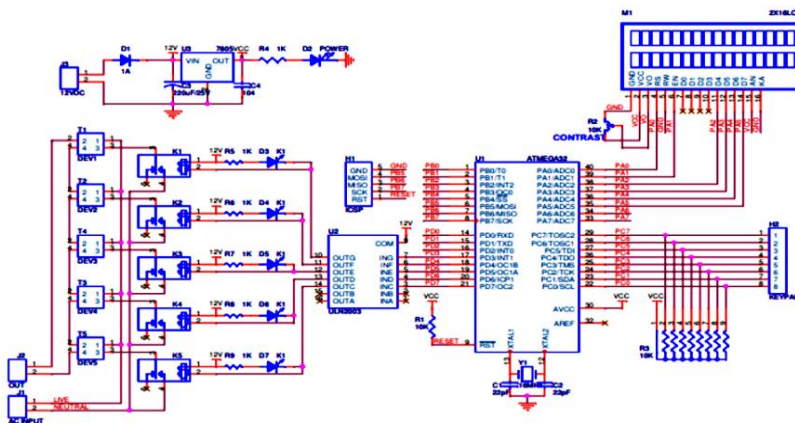

A new automated multirange thermal current converter (TCC) has been designed and implemented at the National Institute of Standards (NIS), Egypt. Five single junction thermal current converters have been connected in parallel on PCB with an LCD, keypad and a microcontroller to control a five fast switching relays. This TCC has been designed to cover the ac current ranges from 500 mA to 5 A at frequencies from 40 Hz up to 10 kHz. The construction of the new automated TCC has been presented to solve some problems of using shunt resistors at high currents. Furthermore, a new automatic calibration system has been established to calibrate the established TCC against another standard TCC. This software program has been specially designed using MATLAB program to overcome the problems of manual calibration and measurement. The ac-dc differences for all ranges

at different frequencies and also the expanded uncertainty had been estimated. The results show that the new TCC improve the accuracy and the uncertainty of the AC current because it overcome the disadvantages of the shunt resistor which used with the traditional TCC to extend the current range. Then this paper proves that this new automated multirange TCC design has a good effect on improving the accuracy and reducing the uncertainty of the AC current measurement at current ranges from 1 A to 5 A at frequencies from 40 Hz up to 10 kHz.

Publication: Nahed Abdelmonaem, Rasha S. M. Ali, and Hamdy Shatla, “International Journal of Power Electronics and Drive Systems (IJPEDS)”, Vol. 14, No. 2, June 2023, ISSN: 2088-8694, DOI: 10.11591/ijpeds.v14.i2.

4.2 Adapted Technique for Calibrating Voltage Dividers of AC High Voltage Measuring Systems

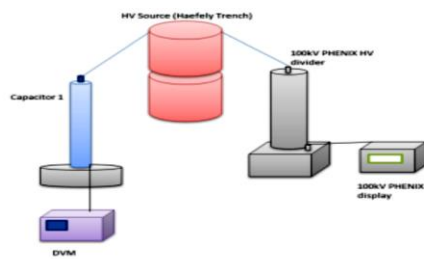

Fig. 1 Calibration setup for 1st capacitor

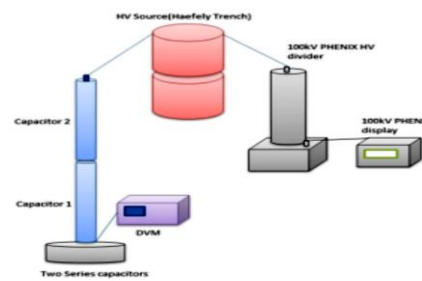

Fig. 3 Calibration setup for 2 capacitors

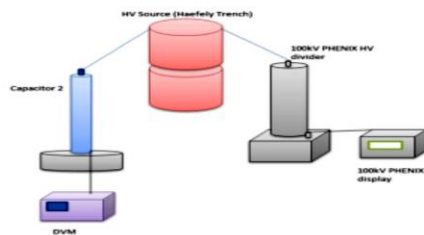

Fig. 2 Calibration setup for 2nd capacitor

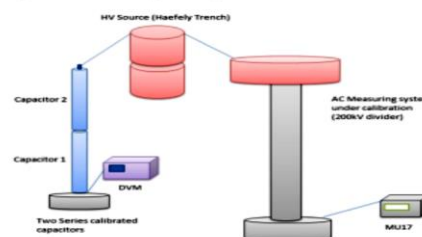
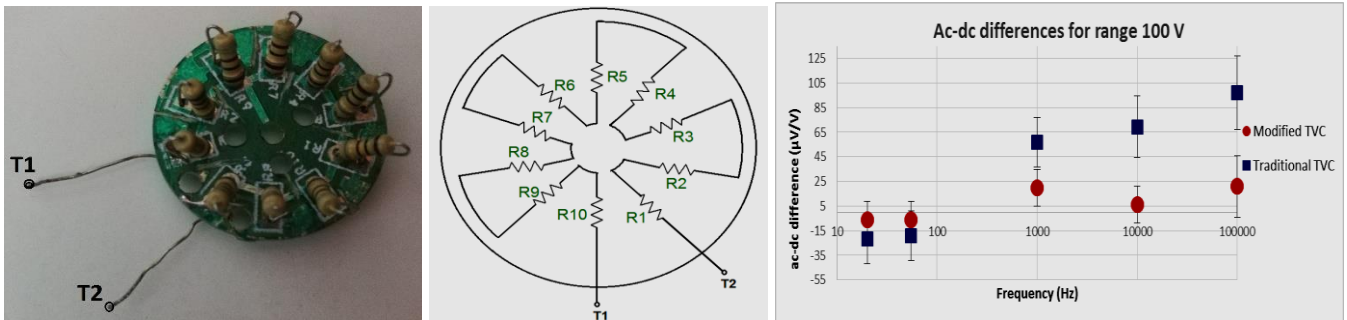

Fig. 4 Calibration setup for 200-kV AC measuring system

This research presents an adapted technique to calibrate the AC voltage divider of AC high-voltage measuring systems up to 200 kV. Two identical capacitors have been used as two similar AC high-voltage capacitive dividers. Firstly, the dividing ratios of two capacitors have been achieved by calibrating each capacitor via a traceable reference standard AC high-voltage divider up to 100 kV. Then, both capacitors have been connected in series to perform as one 200 kV AC voltage divider. They have been calibrated via the same 100 kV reference standard divider to experimentally get their actual dividing ratios up to 100 kV. In order to get their dividing ratios from 100 to 200 kV, a mathematical derivation has been determined. The concept of this derivation is when applying the doubled voltage to two identical pre-calibrated voltage dividers connected in series, their input voltage is almost equally divided across these two dividers. Finally, these calibrated two series capacitors have been used to calibrate a voltage divider of a 200 kV AC HV measuring system. Enhanced uncertainties have been acquired using this proposed adapted calibration technique. The percentage uncertainties reach 0.06% and do not exceed 0.11%. These small uncertainties attained prove the consistency of the proposed calibration technique.

Publication: H. M. Abdel Mageed, and R. S. Salah Eldeen, “MAPAN-Journal of Metrology Society of India”, Vol. 35, No. 1, pp. 11–17, 2020.

4.3 Modified Multipliers Resistors for Measurement of AC Voltages above 50 V



Trials have been done at NIS to increase the accuracy of the high ac voltages measurement above 50 V by using the TVCs. So, a modification in the construction of the high values multiplier resistors is made. This modified multiplier consists of ten metal-film resistors with small power rating. They are connected in series in a radial structure to have a minimal inductance. The high values resistors are mounted in PCB board with high insulation to prevent leakage currents, stray and parasitic capacitances, and dielectric loss across the resistors particularly at high voltages and frequencies. 10 kΩ, 20 kΩ, and 40 kΩ Modified Multipliers Resistors (MMRs) are fabricated to cover 50 V, 100 V, and 200 V ac voltages calibration. The insulated MMR is connected with a UHF single-junction TE to provide a modified TVC. The ac-dc differences of the modified and traditional TVCs are compared to evaluate the performance of the modified TVCs. Their ac-dc differences for ranges up to 50 V are smaller than the traditional TVCs mainly at high frequencies where the differences between them are increased. While at 100 V, and 200 V the ac-dc differences of the modified design TVC is much smaller than the traditional TVC. That is as a result of distributing the power dissipation and reducing the heat generated in each resistor in addition to the radial form and the board high insulation. By studying the effect of the MMR on the measurement accuracy of ac voltages higher than 50 V, it is found that the modified TVCs are also more precise and accurate than the traditional TVCs. That is because the introduced series MMRs eliminate some errors that appear in the traditional multipliers such as skin effect, inductance and capacitance errors, leakage currents and heating effect due to distributing the high concentrated power dissipation especially at high voltages and frequencies.

Publication: Rasha S. M. Ali, "Measurement Journal", Vol. 126, PP. 378-381, October 2018.

4.4 Fully Automated Inductance Measuring System Using New Fabricated Inductance

Box

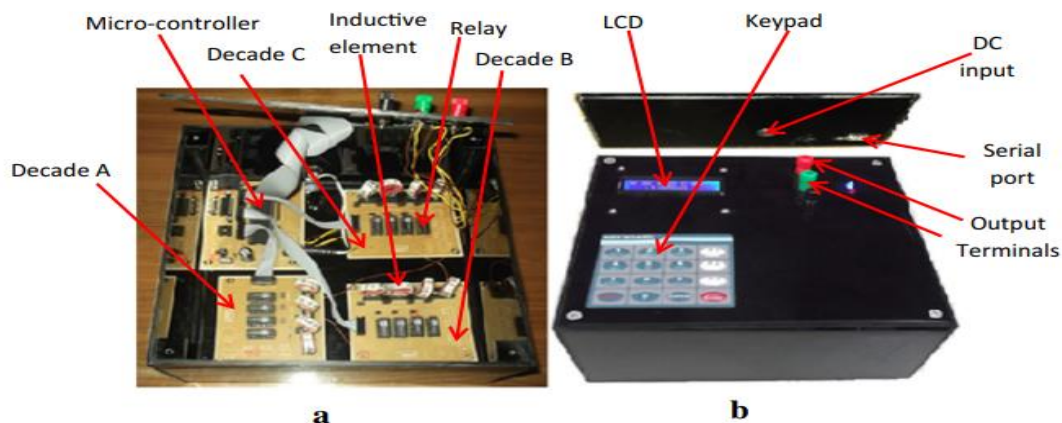

The main aim is constructing a new inductance box providing a huge number of automated inductance steps, which are used in the laboratories to perform full automatic calibration of inductance meters. Therefore, a new inductance box has been introduced that mainly consists of three decades. The three inductance decades have the same design, but each has its four different internal inductive elements. Each decade can generate 15 different inductance values, so it is more economical and practical compared to the other ordinary decades, which produce only 10 values by using 10 internal inductive elements. 1666 different inductance values can be obtained from this inductance box, while 4096 inductance values can be obtained by the possible combinations of its three decades steps. The relative deviation of output inductance steps from their rated values is in the range from $\pm 5 \times 10^{-4}$ to $\pm 5 \times 10^{-3}$, while the maximum relative uncertainty due to the summation effect is less than 60 ppm. It is also practically proved that the new inductance box has better electrical performance than the ordinary old one due to its higher accuracy and lower summation effect uncertainties.

Publication: M. Helmy A. Raouf, A. Eliwa Gad, El-Sayed Soliman A. Said, and M. A. Elwany, "MAPAN-Journal of Metrology Society of India", Vol. 32, No. 3, PP. 199–205, Sept. 2017- doi:10.1007/s12647-017-0210-z

4.5 A Traceable System for Automatic Calibration of DC and AC High Current Sources with Current Coils at NIS

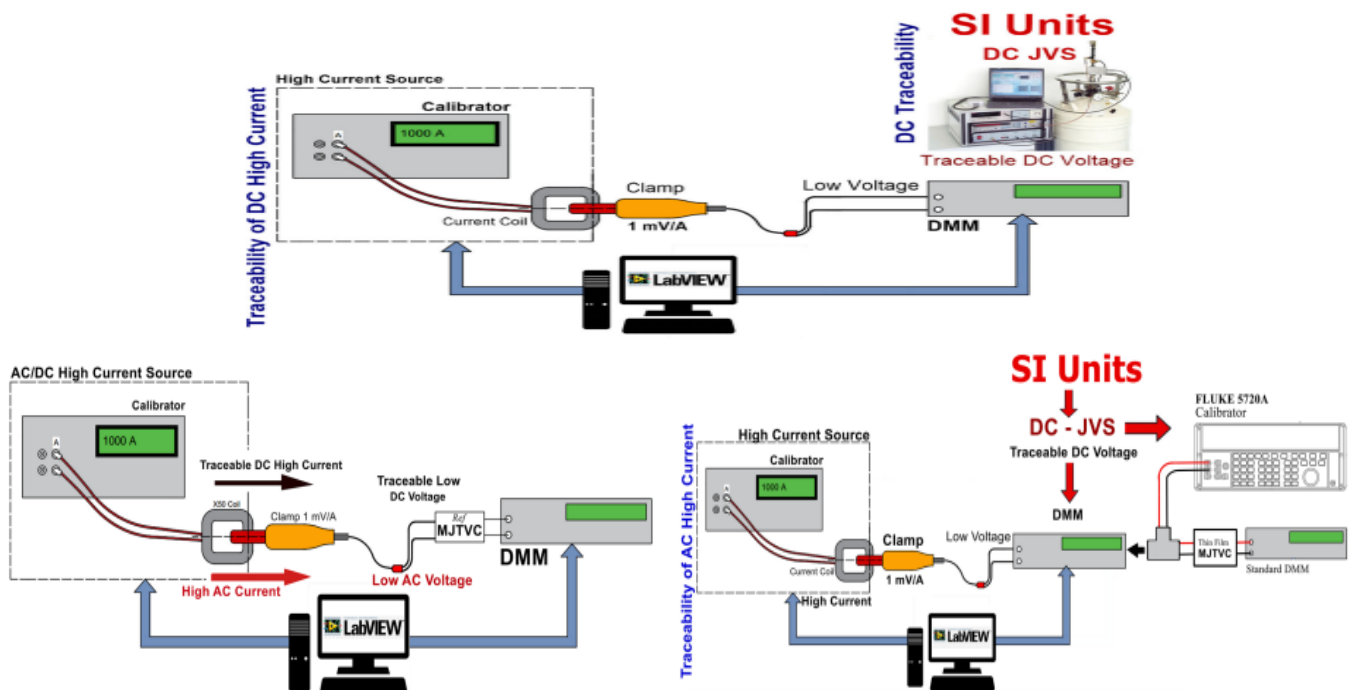

The presented work describes the DC and AC high current calibration techniques up to 1000 A, traceable to the national standards. The paper describes the establishment of traceability of high current DC and AC source without using current transformer; hence it can be useful for many calibration laboratories. The DC high current calibration setup has been demonstrated to realize the traceability of high DC currents to the DC JVS. Two setups have been proposed to calibrate the AC high currents. AC high current calibration using 1 V-MJTVC: thermal converter directly connected to clamp probe can measure the AC current up to 350 A only. This may be due to an electrical

incompatibility between the thermal converter and the clamp probe. However, results of currents less than 350 A were found acceptable based on normalized error (E_n) and error bar graphical representation comparisons. Limitation of AC current calibration setup using 1 V-MJTVC can be overcome by using calibrated DMM traceable to 1 V-MJTVC, which can cover the complete range of AC current calibration up to 1000 A. Actual results associated with their expanded uncertainties for the new calibration systems in DC and AC high currents have been demonstrated. The normalized errors (E_n) and its error bar graphical representations have been presented for a better validation of the methods used. Results show a good agreement between the obtained high current results compared to the reference values based on calibration certificates of the source under test which prove that our new calibration systems are reliable and associated uncertainties were acceptable.

Publication: O. M. Aladdin, Rasha S. M. Ali, Hala M. A. Mageed, and M. A. Elmenyawi, "MAPAN-Journal of Metrology Society of India", Vol. 36, No. 3, PP. 579–587, Sept. 2021.

- O.M. Aladdin, H.M.A. Mageed, Rasha S. M. Ali, M.A. Elmenyawi, "A New Technique for High Current Calibrations Using Low Voltage Reference Standards", IEEE Instrumentation and Measurement Magazine, Vol. 25 (3), pp. 30-36, 2022.

4.6 Remote detection of partial discharge in high voltage insulators based on RF signature

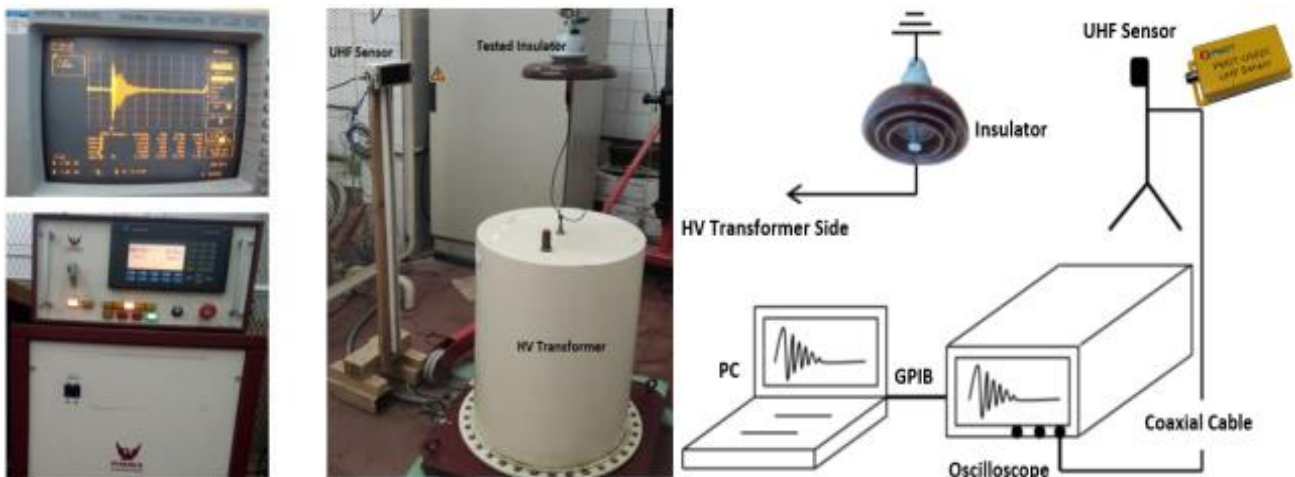

The components of high voltage transmission lines such as towers, insulators, wires, and accessories are continuously subjected to severe environmental conditions. As a result, it is necessary to monitor their health condition to prevent any sudden interruption in the supplied load and to allocate the maintenance investments where they are highly needed. Defective discs of ceramic insulators essentially contain partial discharge (PD) activities; i.e., the presence of PD activities may characterize the insulator's poor condition. The detection of radio frequency (RF) waves emitted from the PD activities is an emerging technique to monitor the insulator's condition during its operation. RF signatures are captured using a high frequency sensor under the normal operating voltage. Signal processing techniques are introduced to the captured RF signatures for further analysis. An Artificial Neural Network (ANN) is used for training of an intelligent classifier that is used for identifying the type of the insulator defect.

Publication: Ahmed S. Haiba, Ahmed Gad, Soliman M. El-Debeikey, Mamdouh M. Halawa, "IEEE Electrical Insulation Conference (EIC)", Calgary, Alberta, Canada, pp. 432-335, 16-19 June 2019.

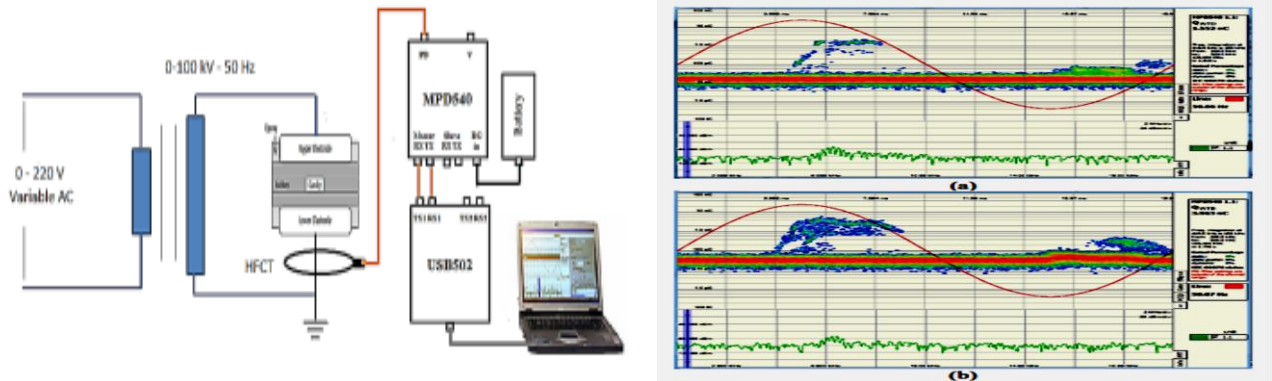

PD measurement was performed on a rubber sample with an artificial variable cavity diameter to discuss the influence of cavity diameter on the behaviour of PD activities. PD measurement was carried out by using HFCT technique indicating that the PD magnitude is strongly depending on the spatial geometry of the cavity inside the insulating material as well as increasing the cavity diameter increases the PD magnitude depending on the applied voltage. The results obtained from the experimental study has a maximum error of 8.20 % based on the maximum PD magnitudes at 30 kV and 50 Hz.

Publication: Ahmed S. Haiba, Adel A. El-Faraskoury, Ahmed D. El-Koshairy, Mamdouh M. Halawa, "TELKOMNIKA Telecommunication, Computing, Electronics and Control", Vol. 19, No. 6, December 2021, pp. 2000-2008.

4.7 Modified Climatic Chamber for solar radiation testing of the outdoor electricity meters



The solar simulator has been established to test the outdoor electricity meters against solar radiation according to the international standard. The simulator was constructed by inserting quartz tungsten halogen lamps (QTH) inside the climatic chamber (MKF-240) that controls ambient temperature to be able to simulate the sunlight. The output irradiance of the simulator was adjusted after many experimental tests to be suitable for testing the electricity meters. Solar testing has been done on two electricity meters with different accuracy classes. The accuracy of the electricity meters was measured during exposure to solar radiation at the operating condition and various electrical loads to know the effect of radiation on electricity meters accuracy.

Publication: Eman M. Hosney, Hala M. Abdel Mageed, and Adel S. Nada, "IEEE Instrumentation and Measurement Magazine", Vol. 25, No. 3, pp. 52– 57, 2022

5. Calibration and Measuring Capabilities (CMCs) at BIPM

5.1 Published CMCs

There are **21 CMCs** published on the BIPM-KCDB website in the different activities such as DC voltage sources and meters, DC current sources and meters, ultra-low values DC current sources resistance standards and meters, AC voltage meters, AC current meters, AC/DC voltage transfer difference, AC/DC Current transfer difference, radio frequency (Scattering parameters), AC power and energy. The published CMCs can be found in the KCDB by clicking on the following link:

<https://www.bipm.org/kcdb/cmc/quick-search?keywords=NIS%2C+Egypt%2C+Electricity+and+Magnatism>

Results for: Electricity and Magnetism > "NIS, Egypt"
21 results

SELECT ALL

EXPORT XLS

In the CMC uncertainty statements, $Q[a,b] = [a^2 + b^2]^{1/2}$

Unless otherwise stated the expanded uncertainties given below correspond to $k = 2$ (at a 95 % level of confidence)

	GROUP ID	SERVICE PROVIDER	INSTITUTE SERVICE CODE	COMMENTS	BRANCH	SERVICE	QUANTITY	INS
<input type="checkbox"/>		Egypt NIS	21.3.1		DC voltage, current, and resistance	DC voltage (up to 1100 V)	DC voltage sources: single values	DC : star
<input type="checkbox"/>		Egypt NIS	21.2.1		Impedance up to the MHz range	Impedance (up to the MHz range)	Capacitance: low-loss capacitors	Fusi
<input type="checkbox"/>		Egypt NIS	21.6.2		DC voltage, current, and resistance	DC current (up to 100 A)	DC current meters: intermediate values	Digi
<input type="checkbox"/>		Egypt NIS	21.4.3		AC voltage, current, and power	AC voltage (up to the MHz range)	AC/DC transfer difference at medium voltage	AC/I Star
<input type="checkbox"/>		Egypt NIS	21.4.1		AC voltage, current, and power	AC current	AC/DC current transfer difference	AC/I star

5.2 Submitted CMCs

There are another two CMCs under evaluation in the DC resistance activity.

CMC IDENTIFIER	METROLOGY AREA	SERVICE CODE	BRANCH	QUANTITY	INSTRUMENT	SUBMITTING RMO
AFRIMETS-EM-EG-00000NXT-1	EM	DC resistance	DC voltage, current, and resistance	DC Resistance (Intermediate values from 10 ohm up to 10 kohm)	Fixed standard resistors (10 ohm to 10 kohm)	AFRIMETS
AFRIMETS-EM-EG-00000NXU-1	EM	DC resistance	DC voltage, current, and resistance	DC Resistance (Low values equal to 1 ohm)	1 Ω fixed standard resistor	AFRIMETS

6. Comparisons

Electrical metrology division at NIS participates in many comparisons to prove its measurement capability. Electrical metrology division laboratories contribute in the comparisons and also will contribute as either participant or pilot. The following tables summarize the list of comparisons that are conducted within the frame of CCEM.

6.1 Completed and Approved Comparisons

There are 13 comparisons that the electrical metrology division at NIS participated in them in the field of electricity and magnetism. The following table listed the comparisons that are completed and approved.

No.	Comparison Identifier	Comparison Title	Status
1	EURAMET.EM-S24	Ultra-Low DC Current Sources	Supplementary Comparison, 2005-2009
2	EURAMET.EM-K2.1	Resistance Standards	Key Comparison, 2010-2011
3	SIM.EM-K12	AC/DC Current Transfer Standards	Key Comparison, 2010-2012
4	APMP.EM-S8	Digital Multimeter	Supplementary Comparison, 2011-2013
5	EURAMET.EM-K12	AC/DC Current Transfer Standards	Key Comparison, 2012-2014
6	BIPM.EM-K11	DC Voltage, Zener Diode	Key Comparison, 2014
7	BIPM.EM-K14.a	Capacitors	Key Comparison, 2016
8	BIPM.EM-K14.b	Capacitors	Key Comparison, 2016
9	AFRIMETS.EM-S1	DC Resistance	Supplementary Comparison, 2015-2018
10	GULFMET.EM-S3	AC/DC Voltage Transfer Standards	Supplementary Comparison, 2017
11	COOMET.EM-K5	AC Power At 50/60 Hz	Key Comparison, 2016-2018
12	AFRIMETS.EM.RF-S1	Attenuation And Reflection for Coaxials	Supplementary Comparison, 2017-2018
13	SIM.EM-S14	AC Energy	Supplementary Comparison, 2018

6.2 Ongoing Comparisons

There are two running comparisons that the electrical metrology division at NIS participated in them. Issuing the draft A reports of them are in progress. In AFRIMETS.EM-S2, NIS is the pilot lab.

Year	Identifier	Description	Participants	Pilot	Status
2020	AFRIMETS.EM-S2	ACV: 100 mV, 100 V, 1000 V @40 Hz 1 kHz. ACI: 10 mA, 1 A, 10 A @40 Hz and 1 kHz. DCI : 10 mA, 1 A, 10 A. DCV : 100 mV, 10 V, 1000 V DC Resistance: 100 kΩ, 1 MΩ, 100 MΩ Artifact: 6 ½ DMM	NMISA, LPEE-LNM, DEF-NAT, KEBS, NIS, UNBS, NMIE, SIRDC- NMI	NIS (DEF-NAT provided artifact)	Draft A is in progress

2018	EURAMET Project 1512	It is aimed to check results of primary level effective efficiency for Type-N thermistor power sensors in the frequency range 10 MHz to 18 GHz. The measurement frequencies for this comparison are 50 MHz, 500 MHz, 1 GHz, 2 GHz, 4 GHz, 6 GHz, 8 GHz, 10 GHz, 12 GHz, 14 GHz, 16 GHz and 18 GHz.	UME, NPL, NIS, PTB, NMISA	UME	Draft A report has been prepared and shared with the participants. Participant's feedback is collected for modifications and corrections.
------	----------------------	--	---------------------------	-----	---

6.3 Planned Comparisons

The following comparison plan was discussed and approved by AFRIMETS,TC-EM in 2022. In AFRIMETS.EM-S4, NIS will be the pilot lab.

Year	Identifier	Description	Participants	Pilot	Status
2022	AFRIMETS.EM-S4	DC & AC High Voltage DC: 5 kV, 10 kV, 20 kV AC @50Hz: 5 kV, 10 kV, 20 kV Artifact: to be identified	NIS, LPEE-LNM, DEF-NAT, TBS	NIS (LPEE-LNM will provide artifact)	Planned (Technical protocol will be prepared by NIS before end of this year)
2023	AFRIMETS.EM-S5	AC Power and energy 50V to 300V 5 mA to 120A 10W to 36000W, VAR PF 0 - 1, Frequency 45 Hz to 65 Hz Artifact: Power and Energy meter	NMISA, LPEE-LNM, KEBS, NIS, TBS, SIRDC-NMI	NMISA (NIS will provide artifact)	Planned (Technical protocol will be prepared by NMISA before end of this year)
2024	AFRIMETS.EM-S6	AC-DC transfer in Voltage: 2 V @ 10 Hz, 1 kHz, 20 kHz, 100 kHz, 1 MHz 200 V @ 10 Hz, 1 kHz, 10 kHz, 20 kHz, 50 kHz, 100 kHz Optional: 1000 V @ 10 Hz, 1 kHz, 10 kHz, 20 kHz, 50 kHz, 100 kHz Artifact: to be identified	NMISA, DEF-NAT, NIS, NMIE, KEBS, TBS, SIRDC-NMI, UNBS	NMISA (will provide artifact)	Planned
2025	AFRIMETS.EM. RF-S2	Radio Frequency power At frequencies 10 MHz, 100 MHz, 1GHz and 18 GHz Power sensors at 1 MW Artifact: power sensor	NMISA, NIS, DEF-NAT,	(NMISA could provide artefact and NIS/DEFANT could write protocol and analyze data)	Planned
2026	AFRIMETS.EM. RF-S3	S-parameters Reflection coefficient S _{ii} (-1, 1) At frequencies: 50 MHz, 1GHz, and 18 GHz Reflection coefficient S _{ij} (magnitude) 0 dB, 40 dB and 80 dB At frequencies: 50 MHz, 1GHz, and 18 GHz S _{ij} (phase) (-180° to 180°) At frequencies: 50 MHz, 1GHz, and 18 GHz Artifact: Attenuators	NMISA, NIS, DEF-NAT	(?? will provide artefact)	Planned

2026	AFRIMETS.EM-K?	Electrical capacitance 1 pF to 1 μ F at 1 kHz	NMISA, NIS, DEF-NAT, SIRDC-NMI, NMIE, KEBS	(?? will provide artefact)	Planned
2026	AFRIMETS.EM-S7	High DC Resistance 1 G Ω to 1 T Ω	NMISA, NIS, DEF-NAT	(?? will provide artefact)	Planned
2026	AFRIMETS.EM-K?	Electrical Inductance 100 mH at 1 kHz Current: 1 mA	NMISA, NIS, DEF-NAT, SIRDC-NMI, NMIE, KEBS	(?? will provide artefact)	Planned

7. NIS Role in AFRIMETS

NIS is participated in many activities in AFRIMETS in the field of electricity and magnetism such as:

- Reviewing CMCs by 4 staff members as one of CIPM-MRA activities.
- Reviewing of the quality system for some NMIs.
- Providing training and consultation to NEWMET members (Ghana).
- Participating in some comparisons as pilot NMI and in other comparisons as a member.
- Hosting some AFRIMETS meetings such as TC-EM in 2019 and will also host the next meeting in August 2023.

8. Projects

There are two projects from 2010 up to 2022 that the electrical metrology division at NIS participated in them in the field of electricity and magnetism which are as following:

8.1 Project 1: “Fabrication and Characterization of Precise System for Generating Low-Level AC Voltage Signals”

This project was in the framework of the executive programme of scientific and technological cooperation between Italy and Egypt for the years 2008 to 2011. Through this project, the following achievements were executed:

- Extending our capabilities to cover all the low ac voltage calibrations. So, several micro-potentiometers were developed from 200 mV to 2 mV.
- The Istituto Nazionale di Ricerca metrological (I.N.Ri.M) Torino, Italy, had been visited by two researchers.
- An inter-laboratory comparison was performed between the NIS micro-potentiometers and the I.N.Ri.M standard and system for generating low voltages.
- Two manuscripts have been published which are:
 - Rasha S.M. Ali, Hala A. Mageed, and N.N. Tadros, “Automated Multi-Meter Method for the scaling of Low AC Voltage from 200 mV to 2 mV”, Energy and Power Engineering (EPE), Vol. 5, PP. 129-134, March 2013.
 - Hala A. Mageed, Rasha S.M. Ali, N. N. Tadros, Mamdouh Halawa, Marco Lanzillotti, “Interlaboratory Comparison in Measuring Low Levels of AC Voltage between Italy and Egypt”, MAPAN-Journal of Metrology Society of India, Vol. 29, PP. 175 – 181, 2014.

8.2 Project 2: “Development of RF and Microwave Metrology Capability (15RPT01)”

This project was arranged under the umbrella of EURAMET that was funded by European Union with the participation of 10 NMIs. The project runtime was from 1 June 2016 to 31 May 2019. Final report

of the project has been issued and published on the EURAMET site, in June 2019. Through this project, the following achievements were executed:

- The collaborators have been trained to use the VNA metrology software VNA Tools to perform VNA measurements.
- Software supports data taking, VNA calibration and error correction and the evaluation of measurement uncertainties in accordance with relevant standards.
- Concluding activity named "software capabilities for measurement uncertainty evaluation" is a measurement comparison in Type-N 50 Ohm up to 18 GHz as a EURAMET project.
- Through this project 3 comparisons were carried out:
 - Final report of the comparison of Type N Reflection coefficient (S-parameter comparison) had been finished and published on the EURAMET site in May, 2019.
 - Final report of the comparison (1426 EURAMET Project) of calibration factor of power sensors and thermistor had been finished and published on the EURAMET site in May, 2019.
 - Final report of the comparison of Voltage reflection coefficient (VRC) of an RF source had been finished and published on the EURAMET site.

9. Patents

9.1 Approved Patents

There are 6 patents were approved (No. 26576, 26040, 26493, 24567, 24446, and 24447) in designing new resistance, capacitance, and inductance decades.

9.2 Patents under Evaluation

9.2.1 Patent Title: Modified Climatic Chamber for solar radiation testing of the outdoor electricity meters

Request No.: 2021/618

9.2.2 Patent Title: Automatic Inductive Voltage Divider with least number of elements.

Request No.: 2018/2105

Section II

Progress Report on Electricity and Magnetism Field at the National Institute of Standards (NIS), Egypt

(From April, 2021 to February, 2023)

**Submitted to: 33rd Meeting of CCEM, 8-9
March, 2023**

1- Calibration and Measuring Capabilities (CMCs)

1.1 Published CMCs

The following CMCs had been approved and published in the BIPM-KCDB website on 12th April, 2021:

1.1.1 AC power and energy: single phase (frequency ≤ 400 Hz), active power: **0 W to 600 W, Power meter**
Relative expanded uncertainty: **$3.6E1 \mu\text{W}/\text{VA}$ to $4.6E1 \mu\text{W}/\text{VA}$**

Voltage: 120 V, Current: 5 A, Frequency: 50 Hz, 53 Hz

Power Factor: 1, 0.5 Lag, 0.5 Lead, 0 Lag, 0 Lead

1.1.2 AC power and energy: single phase (frequency ≤ 400 Hz), active energy : **10 Wh, Energy meter**
Relative expanded uncertainty: **$3.7E1 \mu\text{Wh (VAh)}^{-1}$ to $4.8E1 \mu\text{Wh (VAh)}^{-1}$**

Voltage: 120 V, Current: 5 A, Frequency: 50 Hz, 60 Hz

Power Factor: 1, 0.5 inductive, 0.5 capacitive

Integration time: 60 seconds, at 120 V / 5A / pf = 1;

120 seconds, at 120 V / 5A / pf = 0.5 inductive, 0.5 capacitive

1.1.3 AC voltage, AC/DC transfer difference at higher voltage: **1000 V, AC/DC Transfer Standard**

Relative expanded uncertainty: **$1.0E1 \mu\text{V}/\text{V}$ to $1.8E1 \mu\text{V}/\text{V}$**

Frequency: 55 Hz to 20 kHz

1.1.4 AC voltage, AC/DC transfer difference at medium voltage: **3 V, AC/DC Transfer Standard**

Relative expanded uncertainty: **$6 \mu\text{V}/\text{V}$ to $3.6E1 \mu\text{V}/\text{V}$**

Frequency: 55 Hz to 1 MHz

1.2 Submitted CMCs

There are 2 CMCs under evaluation in the DC resistance activity as following:

1.2.1 DC resistance, DC resistance standards: low values : **1.00 Ω , Fixed resistor**

Relative expanded uncertainty : **$6.0E-1 \mu\Omega/\Omega$**

Direct current comparator bridge (DCC bridge)

Temperature : Oil Bath Temperature : $23^\circ\text{C} \pm 0.1^\circ\text{C}$, Room Temperature: $23^\circ\text{C} \pm 1^\circ\text{C}$

1.2.2 DC resistance, DC resistance standards: Intermediate values: **$1E+01 \Omega$ to $1E+04 \Omega$, Fixed resistor**

Relative expanded uncertainty : **$3.0E-1 \mu\Omega/\Omega$ to $7.0E-1 \mu\Omega/\Omega$**

Direct current comparator bridge (DCC bridge)

Temperature : Oil Bath Temperature : $23^\circ\text{C} \pm 0.1^\circ\text{C}$ for 10 Ohm, Room Temperature: $23^\circ\text{C} \pm 1^\circ\text{C}$

CMC IDENTIFIER	METROLOGY AREA	SERVICE CODE	BRANCH	QUANTITY	INSTRUMENT	SUBMITTING RMO
AFRIMETS-EM-EG-00000NXT-1	EM	DC resistance	DC voltage, current, and resistance	DC Resistance (Intermediate values from 10 ohm up to 10 kohm)	Fixed standard resistors (10 ohm to 10 kohm)	AFRIMETS
AFRIMETS-EM-EG-00000NXU-1	EM	DC resistance	DC voltage, current, and resistance	DC Resistance (Low values equal to 1 ohm)	1 Ω fixed standard resistor	AFRIMETS

2- Comparisons

2.1 Completed and Approved Comparisons

2.1.1 Final Report of Gulfmet-EM-S3 Comparison in calibration of AC-DC Voltage Transfer Standards was completed and published in Metrologia Journal, Volume 58, Number 1A, 18 June 2021.

2.1.2 Final Report of AFRIMETS.EM-S1 supplementary comparison in calibration of resistance standards at 1 Ω , 10 Ω , 100 Ω , 1 k Ω and 10 k Ω was completed and published in Metrologia Journal, Volume 59, Number 1A, 18 February 2022.

2.2 Ongoing Comparisons

There are two running comparisons that the electrical metrology division at NIS participated in them. Issuing the draft A reports of them are in progress.

Year	Identifier	Description	Participants	Pilot	Status
2020	AFRIMETS.EM-S2	ACV: 100 mV, 100 V, 1000 V @40 Hz 1 kHz. ACI: 10 mA, 1 A, 10 A @40 Hz and 1 kHz. DCI : 10 mA, 1 A, 10 A. DCV : 100 mV, 10 V, 1000 V DC Resistance: 100 k Ω , 1 M Ω , 100 M Ω Artifact: 6 ½ DMM	NMISA, LPEE-LNM, DEF-NAT, KEBS, NIS, UNBS, NMIE, SIRDC-NMI	NIS (DEF-NAT provided artifact)	Draft A is in progress
2018	EURAMET Project 1512	It is aimed to check results of primary level effective efficiency for Type-N thermistor power sensors in the frequency range 10 MHz to 18 GHz. The measurement frequencies for this comparison are 50 MHz, 500 MHz, 1 GHz, 2 GHz, 4 GHz, 6 GHz, 8 GHz, 10 GHz, 12 GHz, 14 GHz, 16 GHz and 18 GHz.	UME, NPL, NIS, PTB, NMISA	UME	Draft A report has been prepared and shared with the participants. Participant's feedback is collected for modifications and corrections. Evaluation method was asked by participants and evaluation method has been shared by coordinator.

3- Patents under Evaluation

3.1 Patent Title: Modified Climatic Chamber for solar radiation testing of the outdoor electricity meters

Request No.: 2021/618

3.2 Patent Title: Automatic Inductive Voltage Divider with least number of elements.

Request No.: 2018/2105

4- Research Activities

From April 2021 to February 2023, NIS has published around **10 publications** in scientific journals indexed in SCOPUS. These publications are listed as following:

- O.M. Aladdin, Rasha S.M. Ali, H.M.A. Mageed, M.A. Elmenyawi, "A Traceable System for Automatic Calibration of DC and AC High Current Sources with Current Coils at NIS", Mapan - Journal of Metrology Society of India, Vol. 36 (3), pp. 579-587, 2021.
- E.M. Hosny, H.M.A. Mageed, A.S. Nada, "Solar Radiation Effect on Measurement of the Electronic Energy Meter", IEEE Instrumentation and Measurement Magazine, Vol. 25 (3), pp. 52-57, 2022.
- Rasha S. M. Ali, "Development of Electrical Quantities Primary Standards", Transactions of the Institute of Measurement and Control, Vol. 44 (3), pp. 539-561, 2022.
- E.F. Ahmed, E.-S.S.A. Said, H.M. Abdel Mageed, A.A. Ammar, "A novel interactive technique for load current harmonic reduction for any randomly utilized household equipment", International Journal of Power Electronics and Drive Systems, Vol. 13 (4), pp. 2159-2171, 2022.
- W.A.E.M. Ahmed, H.M.A. Mageed, S.A. Mohamed, A.A. Saleh, "Fractional order Darwinian particle swarm optimization for parameters identification of solar PV cells and modules", Alexandria Engineering Journal, Vol. 61 (2), pp. 1249-1263, 2022.
- O.M. Aladdin, H.M.A. Mageed, Rasha S. M. Ali, M.A. Elmenyawi, "A New Technique for High Current Calibrations Using Low Voltage Reference Standards", IEEE Instrumentation and Measurement Magazine, Vol. 25 (3), pp. 30-36, 2022.
- H.A.M. Hamed, A.E. Gad, M.H.A. Raouf, "New proposed method for traceability dissemination of capacitance measurements", International Journal of Electrical and Computer Engineering, Vol. 11 (3), pp. 1969-1975, 2021.
- M. Khoza, H.M.A. Mageed, A. Mallat, Rasha S.A.Mohammed, G. Aguko, A. Ziti, P.K. Musaaazi, N. Nezir, "AFRIMETS.EM-S1 supplementary comparison of resistance standards, Metrologia, Vol. 59 (1A), art. no. 01003, 2022.
- E. Hesham, M.S. Gadelrab, K. Elsayed, A.R. Sallam, "Modelling Multilayer Communication Channel in Terahertz Band for Medical Applications", International Journal of Communication Networks and Information Security, Vol. 13 (3), pp. 358-365, 2021.
- O.S. Daif, M. Helmy Abd Raouf, M.A. Esmael, A.E.B. Kotb, "Economic design of sleeve rotor induction motor using rotor ends", International Journal of Electrical and Computer Engineering, Vol. 12 (2), pp. 1233-1242, 2022.

5- Improved Measurement Capabilities

5.1 200 kV, and 300 kV AC/DC high voltage dividers were recently purchased for providing outdoor services for customers.

5.2 High performance multifunction calibrator Fluke model 5730A and Amplifier model 5725A, reference multimeter model 8588A, and RF signal generator were newly purchased for improving our measurement capabilities.

5.3 Field strength meter for frequencies from 1 Hz to 40 GHz was recently purchased for adding new customer service.

5.4 Extending scope of customer services by performing conformity assessment to electricity meters and measuring indicators.

5.5 Providing traceability to some NIS standards by calibrating them at BIPM in May, 2022 and sent back after calibration in July, 2022 which are as following:

- Seven standard resistors with values 1 Ohm, 100 Ohm, and 10 kOhm.
- Six fused silica capacitors with values 1 pF, 10 pF, and 100 pF.
- Two Zener diode voltage standard.

5.6 Traceability will be provided to High Performance Multifunction Calibrator Fluke model 5730A and Amplifier model 5725A at NMI.