

BUREAU INTERNATIONAL DES POIDS ET MESURES

Monographie 84/1

INTERNATIONAL INTERCOMPARISON OF RF VOLTAGE

at 100 MHz, 250 MHz, 500 MHz and 1 000 MHz

Final Report  
by  
H. Bayer and D. Janik



1984

Pavillon de Breteuil, F-92310 SEVRES

INTERNATIONAL INTERCOMPARISON  
OF RF VOLTAGE  
AT 100 MHz, 250 MHz, 500 MHz and 1000 MHz  
GT-RF 75-A5  
Final Report of the Pilot Laboratory  
by  
H. Bayer and D. Janik

L I S T   O F   C O N T E N T S

	Page
SUMMARY.....	I
RESUME.....	I
ZUSAMMENFASSUNG.....	II
1. Introduction.....	1
2 The intercomparison scheme.....	2
3. The transfer standards.....	3
4. The relative RF-DC (AC-DC) difference as the quantity to be measured.....	8
5. The measuring methods.....	9
6. The measurement results.....	11
a. the measured mean values.....	11
b. calculation of the weighted mean value.....	12
c. mean deviation of the measuring devices from the weighted mean value.....	25
d. mean deviations and long-term stability of the transfer standards.....	28
7. Conclusions.....	32
8. References.....	33

APPENDIX 1 Complete list of all measurement results as reported  
by the participating laboratories

LIST OF THE TABLES  
AND FIGURES

1. TABLES

page

Table 1	Voltage and current deflections in the zero branch of the balancing bridge system for various galvanometer resistances (referred to a relative voltage deflection of $1 \cdot 10^{-4}$ ).....	4
Table 2	Measured values of the relative RF-DC difference for all participating laboratories and the transfer standards PTB-1 and PTB-2.....	13
Table 3	Measured values of the relative RF-DC difference for all participating laboratories and the transfer standards PTB-3 and OMH-1.....	14
Table 4	The weighted mean values of the relative RF-DC differences for all circulating transfer standards.....	16

2. FIGURES

Fig. 1	Intercomparison patterns for the cycles I (transfer standards PTB-1 and PTB-2) and II (transfer standards PTB-3 and OMH-1).....	2
Fig. 2	Design principle of the PTB-1 and PTB-2 transfer standards.....	3
Fig. 3	Design principle of the PTB-3 and OMH-1 transfer standards.....	6
Fig. 4	Photographs of the standards PTB-1 and PTB-2.....	7
Fig. 5	Photographs of the standards PTB-3 and OMH-1.....	7

	page
Fig. 6 Principle circuit diagram for comparing the resistance mount transfer standards with the primary standard device (a. direct method, b. comparison by aid of a working standard).....	10
Fig. 7 Principle circuit diagram for comparing the thermal converter transfer standards with the primary standard device.....	10
Fig. 8 Measuring results for transfer standard PTB-1	
a) 100 MHz.....	17
b) 250 MHz.....	17
c) 500 MHz.....	18
d) 1000 MHz.....	18
Fig. 9 Measuring results for transfer standard PTB-2	
a) 100 MHz.....	19
b) 250 MHz.....	19
c) 500 MHz.....	20
d) 1000 MHz.....	20
Fig.10 Measuring results for transfer standard PTB-3	
a) 100 MHz.....	21
b) 250 MHz.....	21
c) 500 MHz.....	22
d) 1000 MHz.....	22
Fig.11 Measuring results for transfer standard OMH-1.	
a) 100 MHz.....	23
b) 250 MHz.....	23
c) 500 MHz.....	24
d) 1000 MHz.....	24
Fig.12 Mean deviations $ \overline{\Delta\delta_1} $ for the various measuring devices of the participating laboratories (a.100 MHz, b.250 MHz, c.500 MHz, d. 1000 MHz),.....	26
Fig.13 Mean sytematic deviations $\overline{\Delta\delta_1}$ for the various measuring devices of the participating laboratories (a. 100 MHz, b. 250 MHz, c. 500 MHz, d. 1000 MHz).....	27

Fig. 14	Mean deviations $ \overline{\Delta\delta_s} $ for the four transfer standards averaged over the measuring values of all participating laboratories	
	a) 100 MHz.....	29
	b) 250 MHz.....	29
	c) 500 MHz.....	30
	d) 1000 MHz.....	30
Fig. 15	Long-term deviations of the four transfer standards, calculated from the controlling measurements of the pilot laboratory.....	31

## SUMMARY

This is the Final Report on the International Intercomparison GT-RF 75-A 5. The quantity to be compared is the relative AC-DC difference (or RF-DC difference) of a device which substitutes DC voltage for the RF voltage 1 V at the frequencies 100 MHz, 250 MHz, 500 MHz and 1000 MHz. The comparison was sponsored and organized by the RF working group of the "Comité Consultatif d'Électricité" in the International Office of Weights and Measures. National institutes of the following countries participated: Australia, England, the German Democratic Republic, the German Federal Republic, Hungary, the Soviet Union and the United States of America. Four transfer standards were circulated, two of which were resistance mounts and two thermal converters. The results of the measurements and the evaluations are presented in numerous tables and diagrams. All numerical results - as reported by the participating laboratories - are given in appendix 1. The results show that a remarkably good agreement between almost all measured values could be ascertained. The deviations over all frequency ranges were within  $\pm 0,015$ , but in most cases smaller (within  $\pm 0,005$ )

## RÉSUMÉ

C'est le Rapport Final relatif à la comparaison internationale GT-RF 75-A 5. La grandeur à mesurer est la différence relative CA-CC d'un instrument de mesure remplaçant la tension 1 V d'une haute fréquence par une tension continue. Les fréquences sont 100 MHz, 250 MHz, 500 MHz et 1000 MHz. La comparaison a été organisée et encouragée par le Groupe de travail pour les Grandeurs aux Radiofréquences du Comité Consultatif d'Électricité au Bureau International des Poids et Mesures. Les instituts nationaux des nations suivantes y ont participé: Angleterre, Australie, Hongrie, République démocratique allemande, République fédérale d'Allemagne et l'Union des Républiques socialistes soviétiques. Les étalons de transfert circulés étaient deux montures de résistances et deux convertisseurs à thermoélément. Tous les résultats du mesurage et des évaluations sont présentés dans de nombreux tableaux et diagrammes. Les résultats numériques - comme rapportés par les laboratoires participants - sont présentés dans l'annexe 1. Un résultat essentiel est la bonne concordance des valeurs mesurées. Les écarts se trouvent dans le domaine de  $\pm 0,015$ , mais sont pour la plupart plus petits (entre  $\pm 0,005$ )

## ZUSAMMENFASSUNG

Dies ist der Abschlußbericht über die internationale Vergleichsmessung GT-RF 75- A 5. Die zu vergleichende Meßgröße ist die relative Wechselspannungs- Gleichspannungs - Transferdifferenz bei einer Spannung von 1 V in den Frequenzpunkten 100 MHz, 250 MHz, 500 MHz und 1000 MHz. Organisation und Betreuung der Vergleichsmessung erfolgte durch die Hochfrequenzarbeitsgruppe des "Comité Consultatif d'Électricité" im Internationalen Amt für Maße und Gewichte. Staatsinstitute folgender Länder beteiligten sich an der Vergleichsmessung: Australien, Bundesrepublik Deutschland, Deutsche Demokratische Republik, England, Sowjetunion, Ungarn und Vereinigte Staaten von Amerika. Vier TransfERNormale wurden in Umlauf gesetzt: Zwei von diesen waren Widerstands-Meßköpfe, die anderen zwei waren Thermokonverter. Die Meß- und Auswertungsergebnisse sind in zahlreichen Tabellen und Diagrammen zusammengestellt. Alle von den Teilnehmern gemeldeten Zahlenwerte erscheinen in Anhang 1. Als wesentliches Ergebnis ist festzustellen, daß alle Meßwerte verhältnismäßig gut übereinstimmen. Alle Abweichungen liegen innerhalb  $\pm 0,015$ , sind aber meistens wesentlich kleiner (innerhalb  $\pm 0,005$ )



## 1. Introduction

This international intercomparison of the quantity "voltage" in coaxial guide systems at 100 MHz, 250 MHz, 500 MHz and 1000 MHz frequencies was decided on at the 4th meeting of the Radiofrequency Working Group of the "Comité Consultatif d'Electricité" of the "Bureau International des Poids et Mesures (BIPM)". The official designation of the intercomparison is GT-RF 75-A5. The magnitude of the voltage to be compared was 1 V.

The following national institutes participated:

1. All-Union Scientific Research Institute of Metrology (VNIIM), Leningrad, USSR
2. Amt für Standardisierung, Meßwesen und Warenprüfung (ASMW), Berlin, German Democratic Republic
3. Electrical Quality Assurance Directorate (EQD), Bromley, Kent, England
4. National Bureau of Standards (NBS), Boulder, United States of America
5. National Measurement Laboratory (NML), Lindfield, Sydney, Australia
6. Országos Mérésügyi Hivatal (OMH), Budapest, Hungary
7. Physikalisch-Technische Bundesanstalt (PTB), Braunschweig, Federal Republic of Germany, acting as pilot laboratory

Four transfer standards - two of the resistance mount type and two of the thermal converter type - were made available by two of the participants (three of them by the PTB and one by the OMH). The intercomparison began in September 1976 and was terminated in March 1982, the total period spanning 5 1/2 years.

2. The intercomparison scheme

The two different kinds of transfer standards were circulated in two separate cycles; their petal pattern is shown in Fig. 1. To observe the long-term stability of the standards and to detect any variations, the transfer standards were measured four times at the pilot laboratory in the course of the cycle: one measurement at the beginning, one measurement at the end and two measurements within the run.

*Petal Pattern Diagrams of the Voltage Comparison Circles*

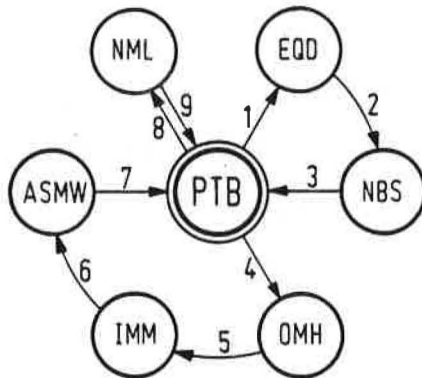

*First Circle with the Transfer Standards PTB I and PTB II*

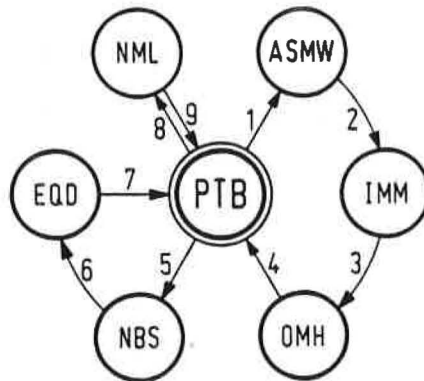

*Second Circle with the Transfer Standards OHM I and PTB III*

Fig.1 Intercomparison patterns of cycles I and II. One of them (cycle I) is for the resistance mount transfer standards (PTB-1 and PTB-2), the other (cycle II) is for the thermal converter transfer standards (PTB-3 and OMH-1)

### 3. The transfer standards

Two coaxial resistance mounts - designated as PTB-1 and PTB-2 - were made available by the PTB. They are basically of the same construction, the only differences being that the coaxial line of the PTB-1 mount is terminated by a matched resistance of  $50 \Omega$ , whereas the PTB-2 mount is terminated by a matched resistance of  $75 \Omega$ ; in accordance with this, the wave impedances of the coaxial input lines within the mounts are  $50 \Omega$  for PTB-1 and  $75 \Omega$  for PTB-2. Both systems have input connectors of the GR-900 type (Fig. 2).

Each mount includes a bridge circuit containing two temperature-sensitive resistors ( $R_3$ ,  $R_4$ ) for balancing when first RF voltage and after that the substituting DC voltage is applied across the input connector plane. A DC battery of 6 V and a suitable null detector were provided by each participant, to supply the bridge circuit.

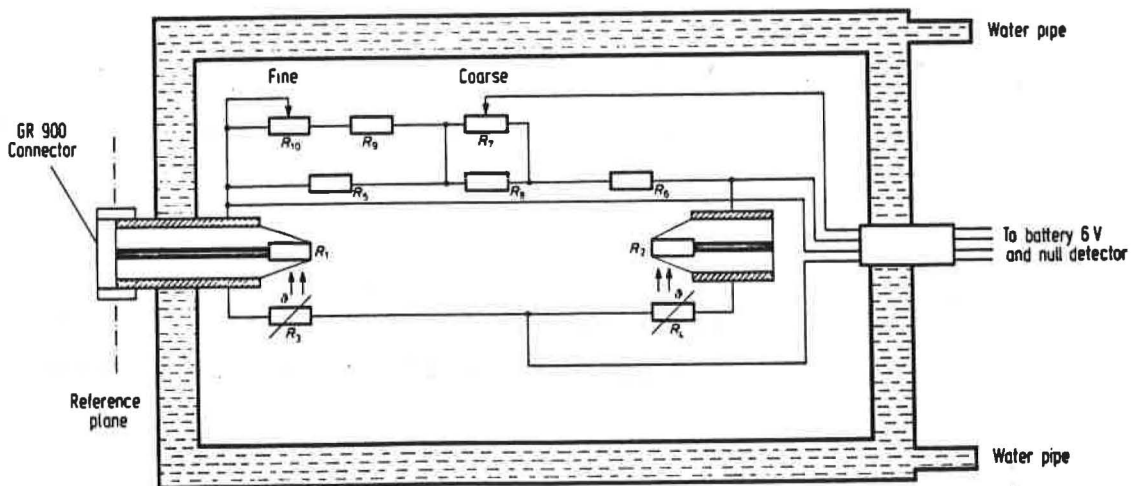

Fig. 2 Design principle of the PTB-1 and PTB-2 transfer standards

The deviations of the voltage (or current) value from its nominal value ( 6 V, or 7.5 mA) should be within  $\pm 10 \%$ . The relative voltage (or current) drift should be smaller than  $3 \cdot 10^{-3} \text{ h}^{-1}$ , because otherwise this drift causes a relative uncertainty exceeding  $1 \cdot 10^{-4}$  in the RF voltage measurement. The resistance of the null detector is not critical. The voltage and current deflections in the zero branch, referred to a variation of  $1 \cdot 10^{-4} \text{ V}$  of the 1 V nominal voltage, are given for various galvanometer resistances in Table 1

TABLE 1

Voltage and current deflections in the zero branch for various galvanometer resistances, referred to a relative voltage deflection of  $1 \cdot 10^{-4}$  \*

Galvanometer resistance k $\Omega$	Voltage deflection $\mu\text{V}$	Current deflection nA
10	2	0.2
1	1	1
0.2	0.4	2
0	0	2.5

\* These values are valid for the PTB-2 transfer standard, the values for PTB-1 must be increased by the factor 1.5

A bridge balance is possible for RF input voltages between 0.7 V and 1.2 V. Because the relative RF-DC difference (see sect. 4) is slightly dependent on the input voltage level, it should be within  $1 \text{ V} \pm 0.05 \text{ V}$ . The heat transfer time constant between the RF measuring resistor  $R_1$  and the temperature-sensitive resistor  $R_3$  is about 12 s. The time period for one measurement of the RF-DC difference is between 5 and 10 minutes.

Each standard resistance mount is surrounded by a water jacket. The temperature of the water flow through this jacket - emerging from a temperature-stabilized water bath - must be within  $\pm 0.01$  K over the time of the measuring period. The influence of these small fluctuations on the bridge system is less than  $2 \cdot 10^{-4}$  with respect to the RF input voltage. The difference between bath temperature and room temperature should not exceed  $\pm 4$  K. When the measurements are carried out in a temperature-controlled room, the fluctuations of which are sufficiently small ( $\leq 0.5$  K), instead of using a running water flow, the jackets may be filled with water.

The influence of the level of the room temperature is not very critical; it should be between  $20^{\circ}\text{C}$  and  $25^{\circ}\text{C}$ .

The reference plane for the voltage measurement is the front plane of the GR-900 connector (this is exactly the end plane, when the centering gear ring of the connector is removed).

The PTB-3 and OMH-1 transfer standards are thermal converters incorporating a T connection in the converter housing. The output connector of PTB-3 is of the N male type and that of OMH-3 is of the GR-900 ( $50 \Omega$ ) type. The interfaces of these connectors are the reference planes for the voltage comparison (Fig. 3). A voltage of 1 V across the reference plane produces a thermocouple response of 4 mV (PTB-3) or 7 mV (OMH-1).

Fig. 4 and Fig. 5 show the photographs of all circulating transfer standards (resistance mounts and thermal converters).

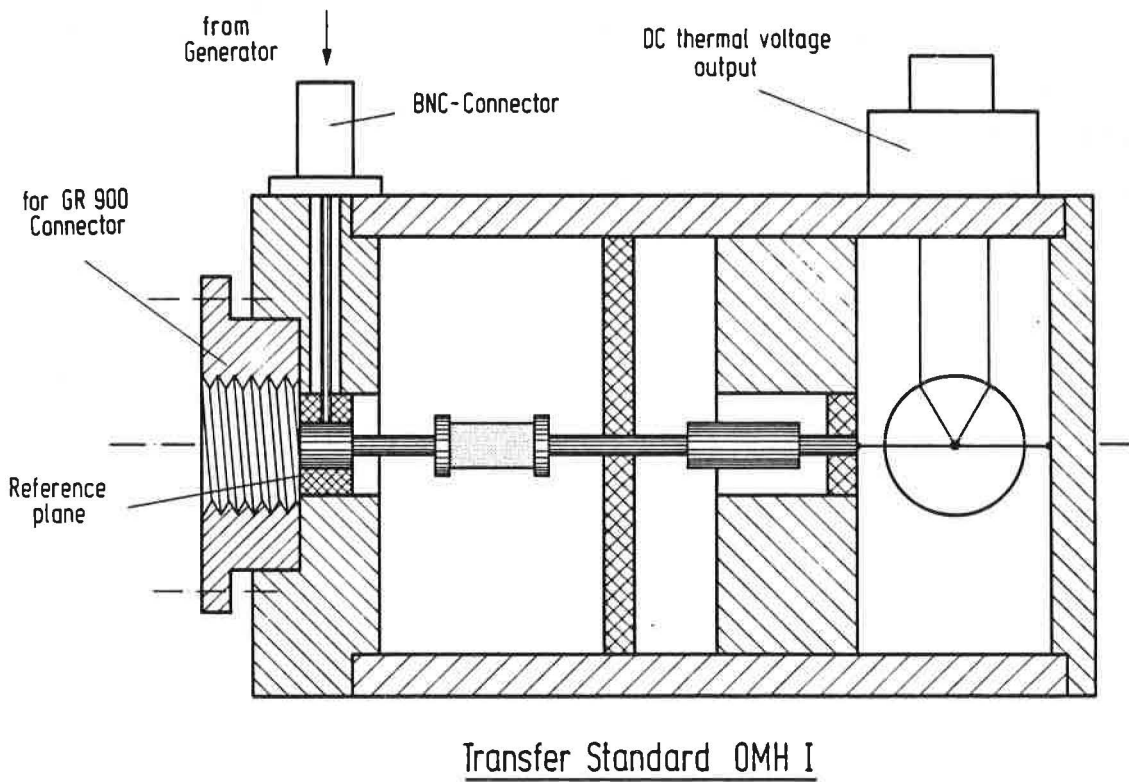
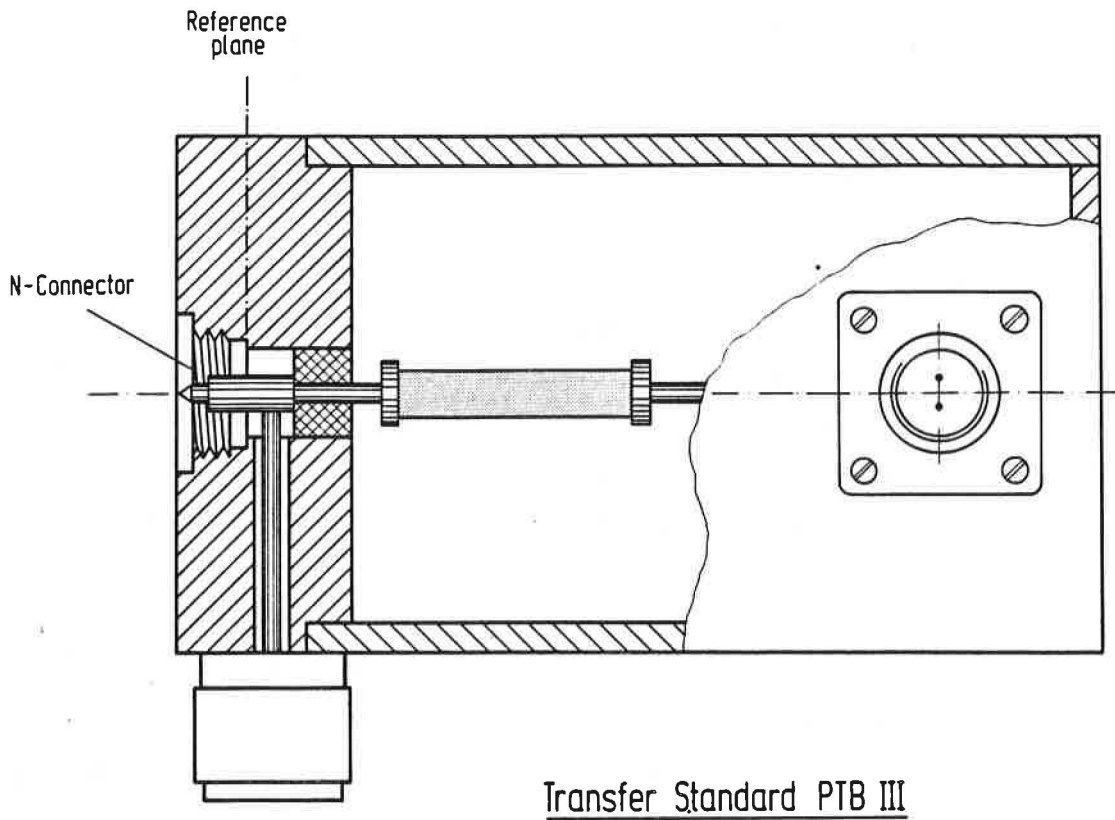

Fig. 3 Design principle of the PTB-3 and OMH-1 transfer standards

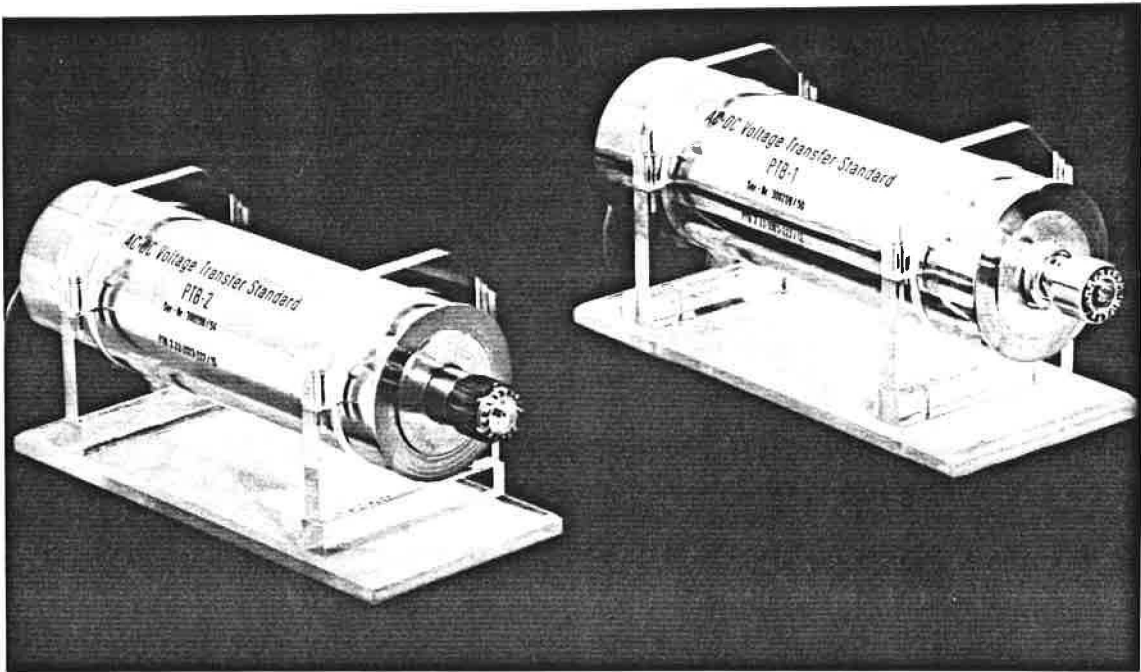

Fig. 4 Photograph of the PTB-1 and PTB-2 resistance mount transfer standards

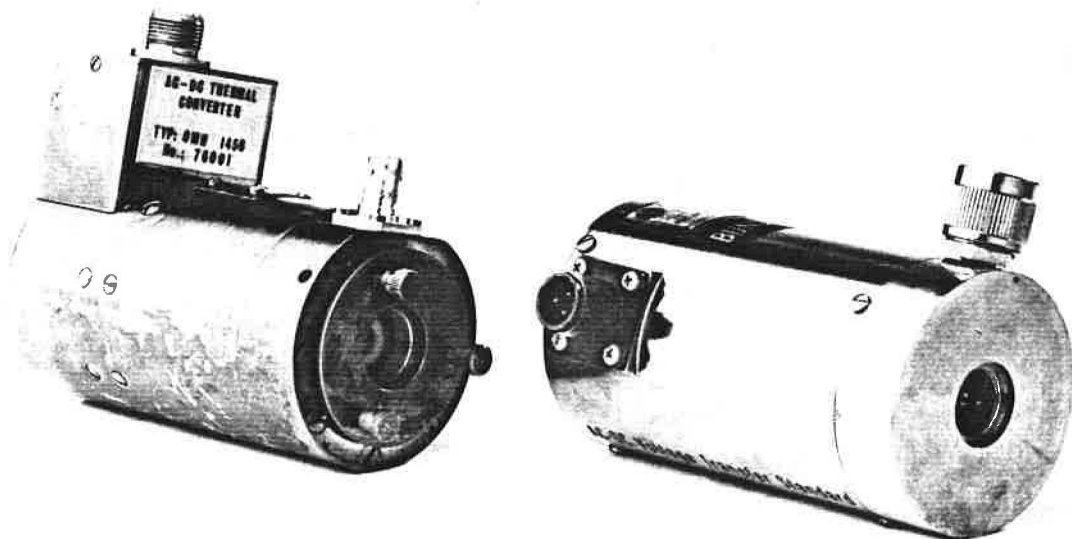

Fig. 5 Photograph of the PTB-3 and OMH-1 thermal converter transfer standards

4. The relative RF-DC difference as the quantity to be measured and compared

The quantity to be measured is the relative RF-DC difference, defined by

$$\delta = \frac{U_{RF} - U_{DC}}{U_{DC}} \quad (1)$$

$U_{RF}$  is the magnitude of a sufficiently constant RF voltage applied across the connector input plane of the resistor mount transfer standard, or the voltage emerging from the reference plane of the output connector of a thermal converter transfer standard. In the latter case, the input of the thermal converter is connected with the output of a stable RF generator.  $U_{DC}$  is chosen as the mean value of the two  $U_{DC}$  values measured at opposite polarities

$$U_{DC} = \frac{1}{2} (U_{DC}^+ + U_{DC}^-) \quad (2)$$

and effecting the same bridge balance or thermal element output voltage as the RF voltage to be measured.

The following expression is valid for the uncertainty of the RF voltage:

$$\frac{\Delta U_{RF}}{U_{RF}} \approx \frac{\Delta \delta}{1 + \delta} \quad (3)$$

resulting from (1) if  $\frac{\Delta U_{DC}}{U_{DC}} \ll \frac{\Delta U_{RF}}{U_{RF}}$  ; therefore

$$\frac{\Delta U_{RF}}{U_{RF}} \approx \Delta \delta, \text{ if } \delta \ll 1 \quad (4)$$



The RF voltages fed to the transfer standards are determined in the standard measuring device of each participating laboratory. When the relative RF-DC difference of the transfer standards is measured, the reference planes for the voltage measurement must be the same for the standard device and the transfer standard.

The random uncertainties are calculated for a statistical probability of 99.73% (3  $\sigma$  value). They are combined with the estimated systematic uncertainty (of the same confidence level) by a quadratic summation.

#### 5. The measuring methods

The principal measuring method for a voltage comparison applying resistance mount transfer standards is as follows:

The RF voltage to be used for determining the relative RF-DC difference  $\delta$  is generated and measured by means of the standard devices of each laboratory. This same voltage is then applied across the connector input plane of the resistance mount transfer standards (with an identical reference plane in both cases). The bridge circuit incorporated into each transfer standard is balanced. The RF voltage is then substituted by DC voltage which results in the same zero balancing as the RF voltage. The polarity of the DC voltage is then reversed and the measurement is repeated once more.  $\delta$  is then calculated applying Equations (1) and (2) (Fig. 6).

When thermal converters with an incorporated T branch are used as transfer standards, it must be considered that the voltage to be compared is then generated at the reference plane of its output connector. Since the devices are fitted with suitable T branches the generator is connected to the input connector of the T branch and the national standard device to the output connector. The thermocouple output voltage is observed and the RF voltage is then replaced by DC voltage across the output plane (reference plane) of the transfer standard, resulting in the same thermocouple output voltage as before. Considering both polarities for the DC measurement and taking the mean value of both these DC measurements, the relative RF-DC difference is calculated using Equation (1) and (2) (Fig. 7).

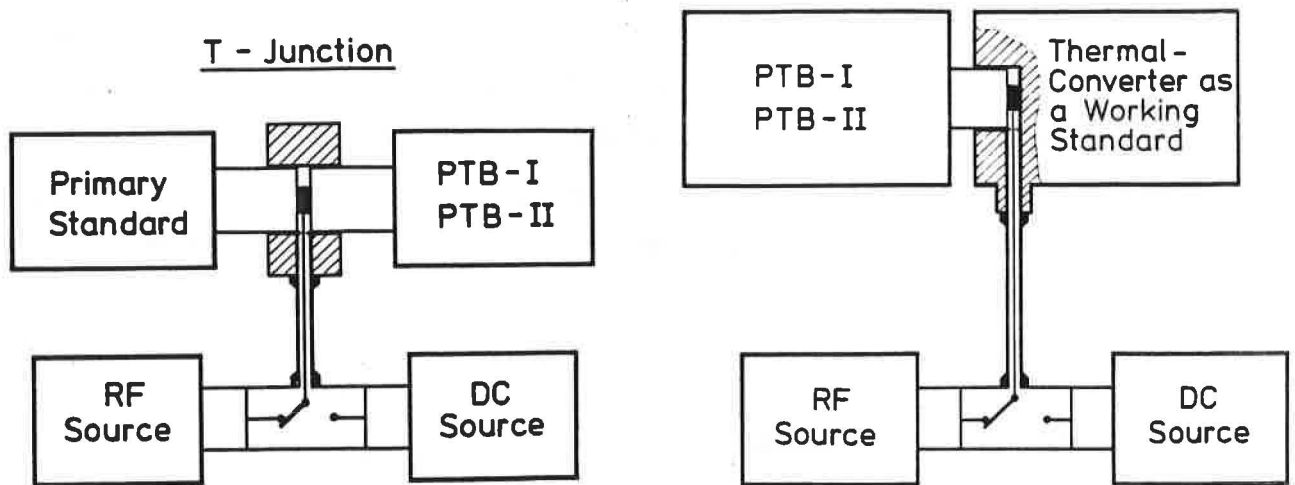

Fig. 6 a,b Principle circuit diagram for comparing the resistance mount transfer standards with the primary standard device

a) direct method

b) comparison by aid of a working standard

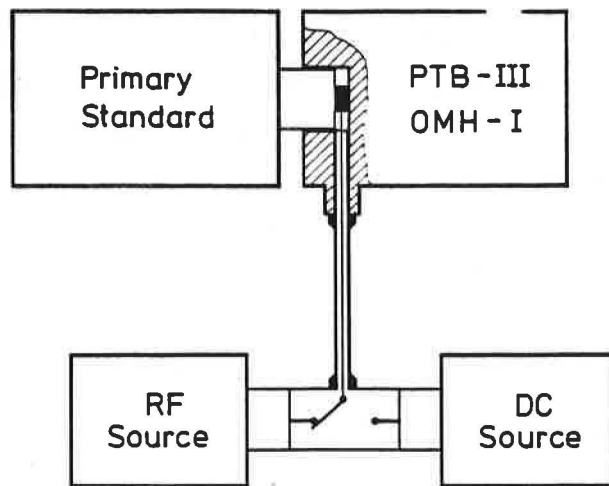

Fig. 7 Principle circuit for comparing the thermal converter transfer standards with the primary standard

Most laboratories used coaxial power standards with well-known input impedances as RF voltage standards (ASMW, EQD, NML, PTB, VNIIM). One of the PTB primary standard devices is a resistance power mount system and the other a bolovac system (bolovac = bolometric voltage and current standard) equipped with a dual bead thermistor. If a primary standard was not available in both connector types applied (GR 900, N) an adapter was added. This was done e.g. for tracing the PTB-3 transfer standard (N male connector) to the primary devices of the EQD and the NML, fitted with GR 900 connectors. The necessary corrections for the reference plane displacements were calculated by applying the transmission-line formulas. The RF voltage standard devices were directly coupled to the measuring ports of the transfer standards in the case of PTB-3 and OMH-1.

For the measurements on PTB-1 and PTB-2, some laboratories (EQD, PTB, VNIIM) applied special T connections (GR 900) for combining the transfer standards to be measured and the primary standard devices. Other laboratories (ASMW, NBS, NML) compared the transfer standards with a working standard (thermal converters with built-in T connectors) calibrated with their primary standards. A peak voltage detection method (slide back voltmeter) was additionally applied by the VNIIM.

## 6. The measurement results

### a) The measured mean values

The relative RF-DC difference - as defined in Equation (1) - was the quantity to be measured. The ambient temperature in the measuring rooms of the various participants varied between + 20°C (NBS, Boulder) and + 24°C (OMH, Hungary). The relative room humidity was always between 40% and 55%. The relative deviations of the measuring frequency were - as far as specified - in all cases smaller than  $1 \cdot 10^{-4}$ . For evaluating the mean value for one measurement, the number of single measurements was between 3 and 15. The random uncertainty was rather small compared with the systematical one;

The confidence level, to which the latter was referred, is not always clearly indicated by the participants; 95% or 99% must be assumed. The total uncertainties, which were rather dependent on the frequency and on the particular measuring device, varied between  $\pm 0.003$  and  $\pm 0.002$ .

The single measurement values are designated as follows:  $\delta_{iqls}$  (i = number of the single measurement, q number of the period during which was measured, l number of the laboratory, s number of the transfer standard). The mean values reported to the pilot laboratory are

$$\bar{\delta}_{qls} = \frac{1}{k} \sum_{i=1}^k \delta_{iqls} \quad (5)$$

(k = total number of single measurements within one measuring period q). These values are given in Table 2 and Table 3.

b) Calculation of the most probable measurement value  
(weighted mean value)

For determining the most probable measurement value, a "weighted mean value" was calculated \*. To avoid that the results of those laboratories which measured the same transfer standard more than once (e.g. the pilot laboratory) will be evaluated with an r times higher weighting factor (if r is the number of measuring periods for the same standards), only the mean value

$$\bar{\delta}_{ls} = \frac{1}{r} \sum_{q=1}^r \delta_{qls} \quad (6)$$

is considered for calculating the weighted mean value; this is defined by

$$\bar{\delta}_{sw} = \sum_{l=1}^m \delta_{ls} G_{ls} \quad (7)$$

m is the number of participating laboratories and  $G_{ls}$  is the weighting factor by which the confidence in the measurement of the laboratory (l) on the transfer standard (s) is expressed.

---

\* applying a method proposed by BAYER (to be published)

TABLE 2

Measured values of the relative RF-DC difference  $\delta$  for all participating laboratories and the PTB-1 and PTB-2 transfer standards

Laboratory	TRANSFER STANDARDS								Measuring period	
	PTB - 1				PTB - 2				Month	Year
	100 MHz	250 MHz	500 MHz	1000 MHz	100 MHz	250 MHz	500 MHz	1000 MHz		
PTB	0.00224	0.00379	0.00320	- 0.00434	0.00226	0.00434	0.00834	0.00505	11	76
EQD	0.0017	0.0020	- 0.0004	- 0.0047	0.0022	0.0029	0.0057	0.0081	1	77
NBS	0.0011	0.0030	0.0036	- 0.0025	0.0011	0.0034	0.0092	0.0083	1	78
PTB	0.00195	0.00344	0.00294	- 0.00480	0.00200	0.00378	0.00802	0.00844	6	78
OMH	0.0045	0.0059	0.0048	- 0.0017	0.0044	0.0034	0.0091	0.0043	12	78
VNIIM	0.0022	0.0039	0.0043	- 0.0022	0.0010	0.0057	0.0075	0.0040		80
ASMW	0.0018	0.0065	0.0027	- 0.0011	-	-	-	-	2	81
PTB	0.00203	0.00346	0.00287	- 0.00350	0.00185	0.00375	0.00825	0.00697	5	81
NML	0.0033	0.0068	0.0064	- 0.0020	0.0033	0.0042	0.007	0.007	12	81
PTB	0.00199	0.00341	0.00299	- 0.00340	0.00196	0.00371	0.00785	0.00689	3	82

TABLE 3

Measured values of the relative RF-DC difference  $\delta$  for all participating laboratories and the PTB-3 and OMH-1 transfer standards

Laboratory	<u>TRANSFER STANDARDS</u>								Measuring period	
	PTB - 3				OMH - 1					
	100 MHz	250 MHz	500 MHz	1000 MHz	100 MHz	250 MHz	500 MHz	1000 MHz	Month	Year
OMH	-	-	-	-	0.00314	0.0228	0.0084	0.092	9	76
PTB	0.0110	0.0563	0.1196	- 0.2079	0.0068	0.0284	0.0188	0.1171	10	77
ASMW	0.009	0.049	0.098	- 0.217	0.007	0.030	0.023	0.110	1	78
VNIIM	0.009	0.053	0.118	- 0.203	0.004	0.028	0.021	0.112	11	78
OMH	0.0098	0.0516	0.1157	- 0.2111	0.0073	0.0281	0.0203	0.1169	2	79
PTB	0.0110	0.0558	0.1193	- 0.2080	0.0071	0.0289	0.0193	0.1142	6	79
NBS	0.0105	0.0549	0.1216	- 0.2022	0.0037	0.0235	0.0135	0.1031	12	79
EQD	0.01025	0.05160	0.11337	- 0.20984	0.00681	0.0260	0.0143	0.1137	2	80
PTB	0.0110	0.0557	0.1190	- 0.2092	0.0072	0.0287	0.0186	0.1157	7	80
NML	0.0122	0.0548	0.1134	- 0.2200	0.0087	0.0300	0.0185	0.1184	7	81
PTB	0.01092	0.05560	0.11821	- 0.20896	0.00709*	0.02921*	0.02334*	0.05839*	3	82

\* measuring values after inserting a new thermocouple

If this confidence is proportional to a numerical value  $g_{1s}$ , we have

$$G_{1s} = \frac{g_{1s}}{\sum_{l=1}^m g_{1s}} \quad (8)$$

$$\sum_{l=1}^m G_{1s} = 1 \quad (9)$$

To estimate a reasonable value for  $g_{1s}$ , it was assumed that those mean values have the highest confidence, for which the measuring uncertainties are small and for which the sum of all distances to the other mean values (for the same transfer standard) are also small, and that the confidence decreases considerably beyond special limits of  $\Delta\delta_{1s}$  and  $d_{1s}$  ( $\Delta\delta_{1s}$  = total measuring uncertainty,

$$d_{1s} = \sum_{l'=1}^m |\delta_{1s} - \delta_{1s}'|$$

Thus the following was defined

$$g_{1s} = \frac{1}{d_{1s} \Delta\delta_{1s}} e^{-\frac{d_{1s}}{(d_s)_{\min}} \left(1 + \frac{\Delta\delta_{1s}}{\Delta\delta_s}\right)} \quad (10)$$

Where  $\overline{\Delta\delta_s}$  is the mean uncertainty averaged over all measured uncertainties of the mean values for a particular transfer standard and  $(d_s)_{\min}$  is the smallest value of  $d_{1s}$  for the measurements of all laboratories 1 on the standards.

The uncertainty of the weighted mean value is then

$$\Delta\overline{\delta}_{sw} = \sqrt{\sum_{l=1}^m (\Delta\delta_{1s})^2 G_{1s}^2} \quad (11)$$

corresponding to the confidence level for which the  $\Delta\delta_{1s}$  are given.

If this algorithmus is applied for the mean values  $\overline{\delta_{1s}}$  to be measured for the various transfer standards and frequencies, the weighted mean values will result corresponding to Table 4.

TABLE 4

The weighted mean values for the relative RF-DC transfer difference of all transfer standards

Frequency MHz	Weighted mean values $\overline{\delta}_{sw}$			
	PTB-1	PTB-2	PTB-3	OMH-1
100	0.0022 <u>+</u> 0.0016	0.0023 <u>+</u> 0.0016	0.0102 <u>+</u> 0.0015	0.0069 <u>+</u> 0.0014
250	0.0044 <u>+</u> 0.0017	0.0037 <u>+</u> 0.0018	0.0534 <u>+</u> 0.0019	0.0286 <u>+</u> 0.0018
500	0.0039 <u>+</u> 0.0023	0.0079 <u>+</u> 0.0022	0.1165 <u>+</u> 0.0023	0.0193 <u>+</u> 0.0023
1000	-0.0025 <u>+</u> 0.0030	0.0069 <u>+</u> 0.0026	-0.2090 <u>+</u> 0.0029	-0.1147 <u>+</u> 0.0029

In Fig. 8 to 11, the distances of the measured values  $\delta_{ls}$  from the above-given weighted mean values  $\overline{\delta}_{sw}$

$$\Delta\delta_{ls} = \delta_{ls} - \overline{\delta}_{sw} \quad (12)$$

are shown for all laboratories, transfer standards and frequencies.

The range between the limits of uncertainty for the weighted mean value is emphasized by a dotted ground.



Transfer - Standard: PTB-I

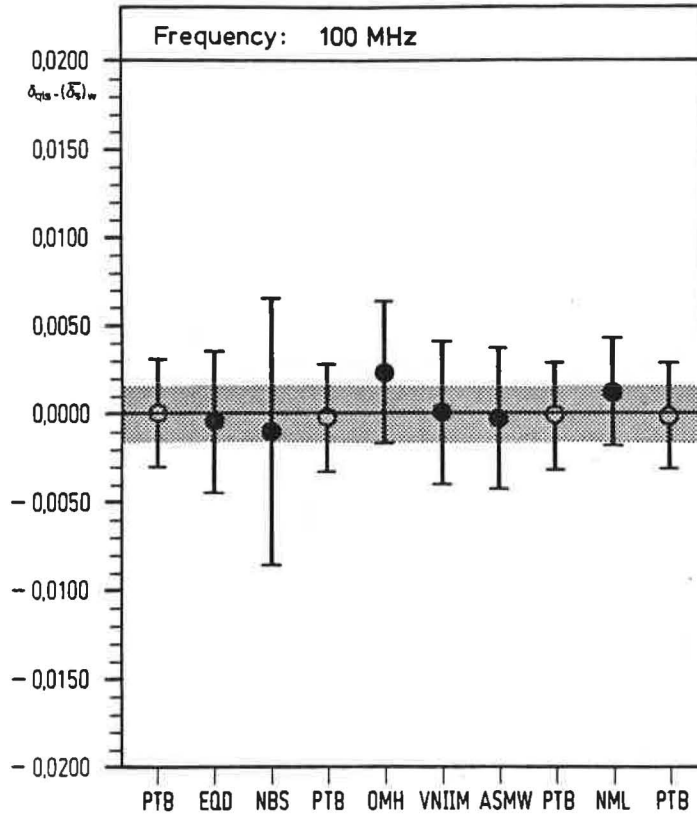

Fig. 8a

Transfer - Standard: PTB-I

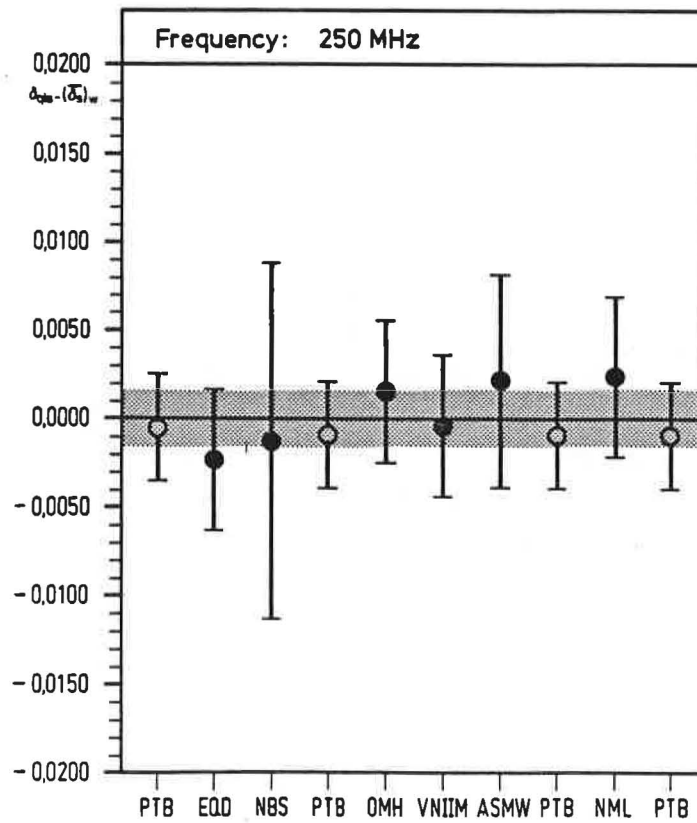

Fig. 8b

Transfer - Standard: PTB-I

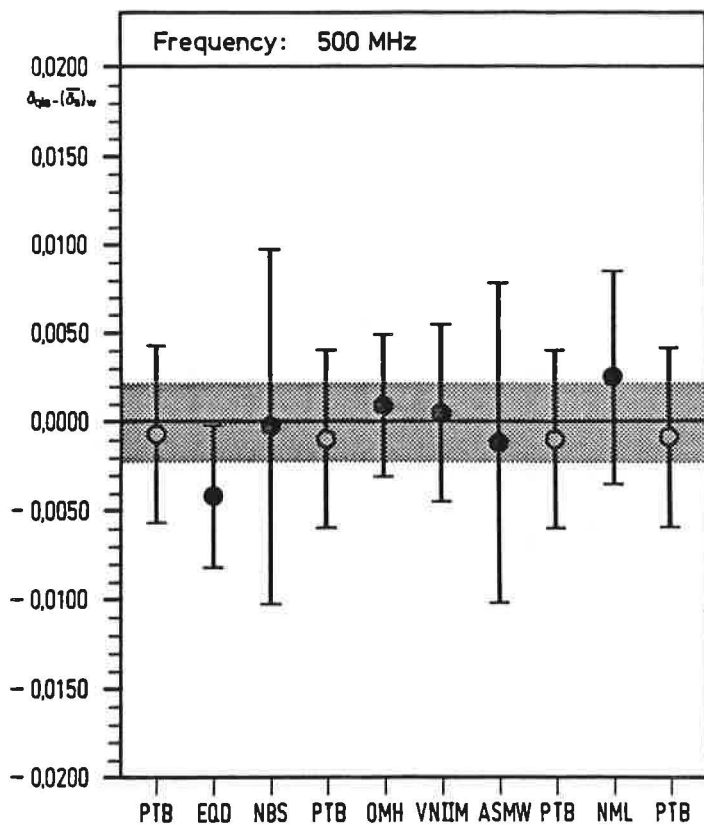

Fig. 8c

Transfer - Standard: PTB-I

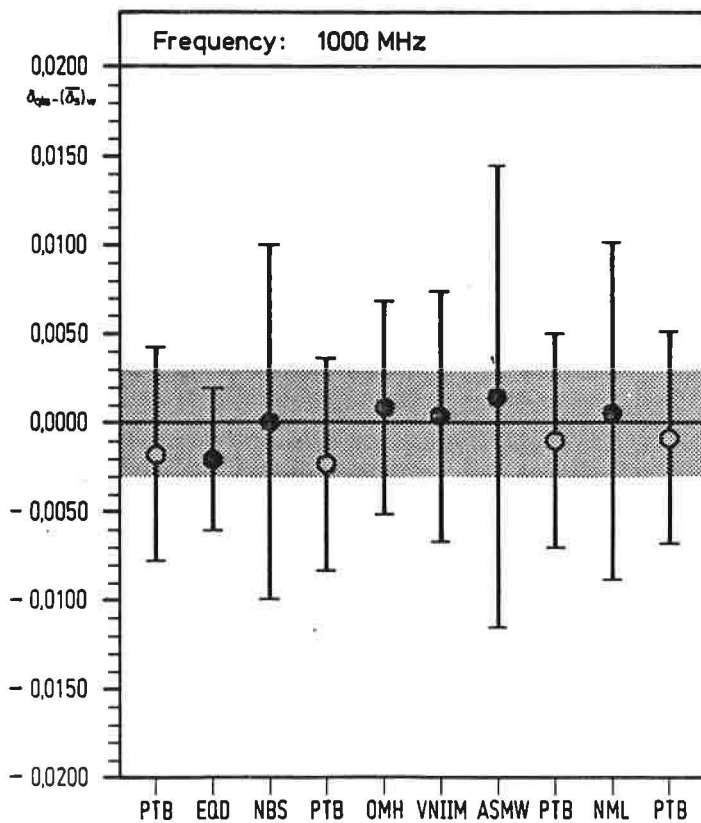

Fig. 8d

Transfer - Standard: PTB-II

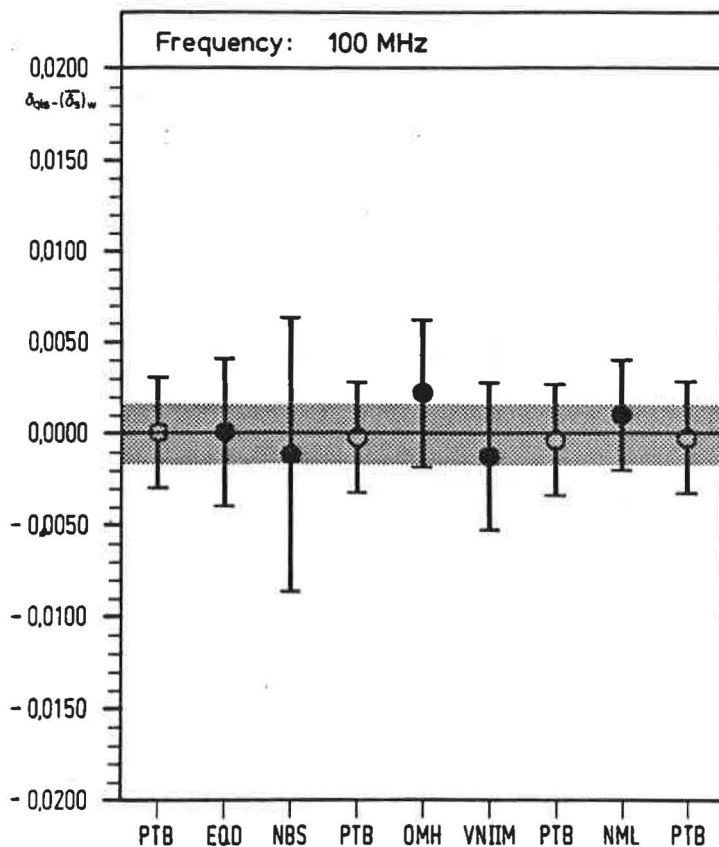

Fig. 9a

Transfer - Standard: PTB-II

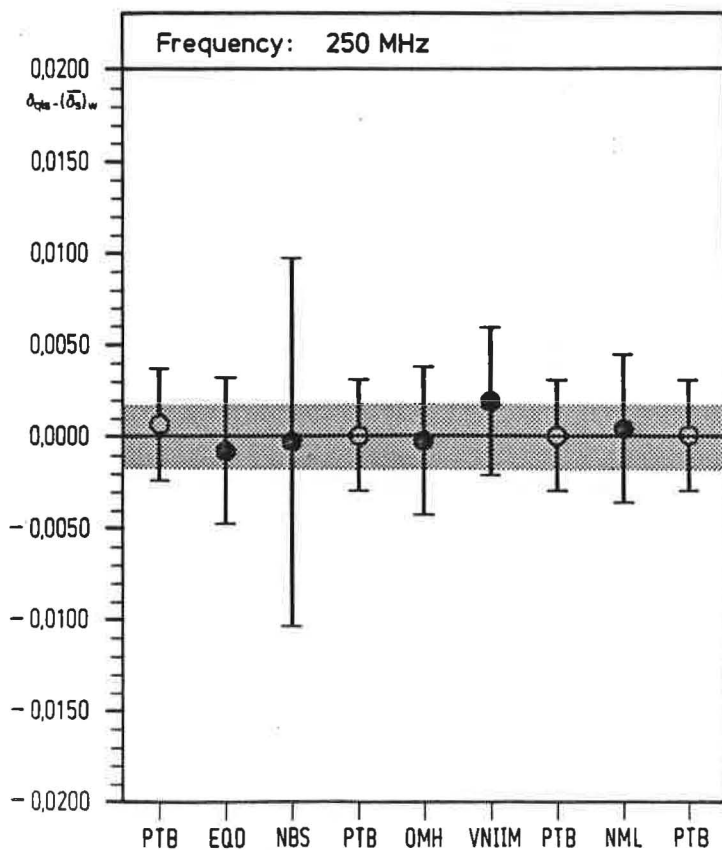

Fig. 9b

Transfer - Standard: PTB-II

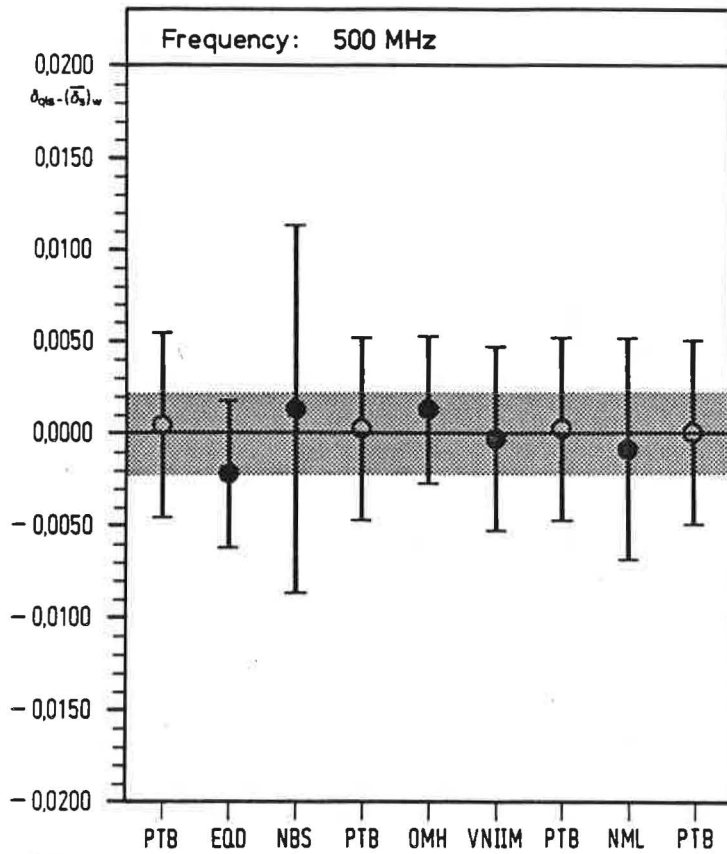

Fig. 9c

Transfer - Standard: PTB-II

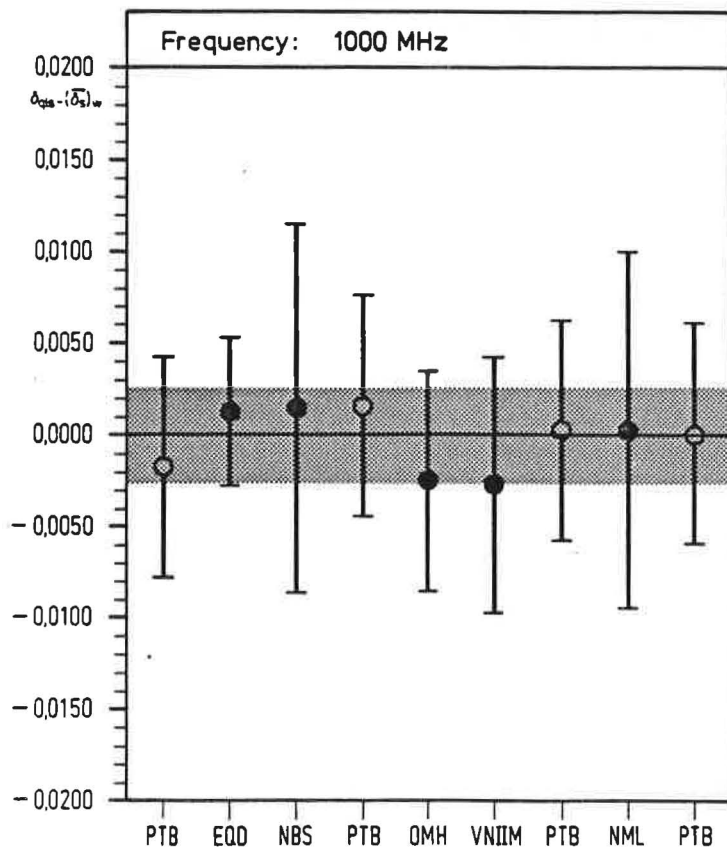

Fig. 9d

Transfer - Standard: PTB-III

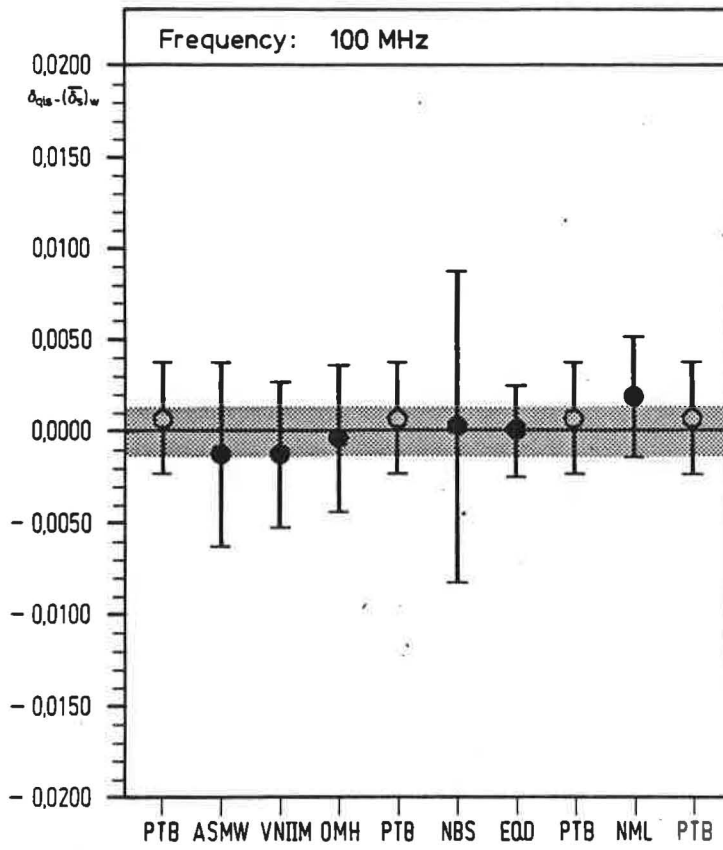

Fig. 10a

Transfer - Standard: PTB-III

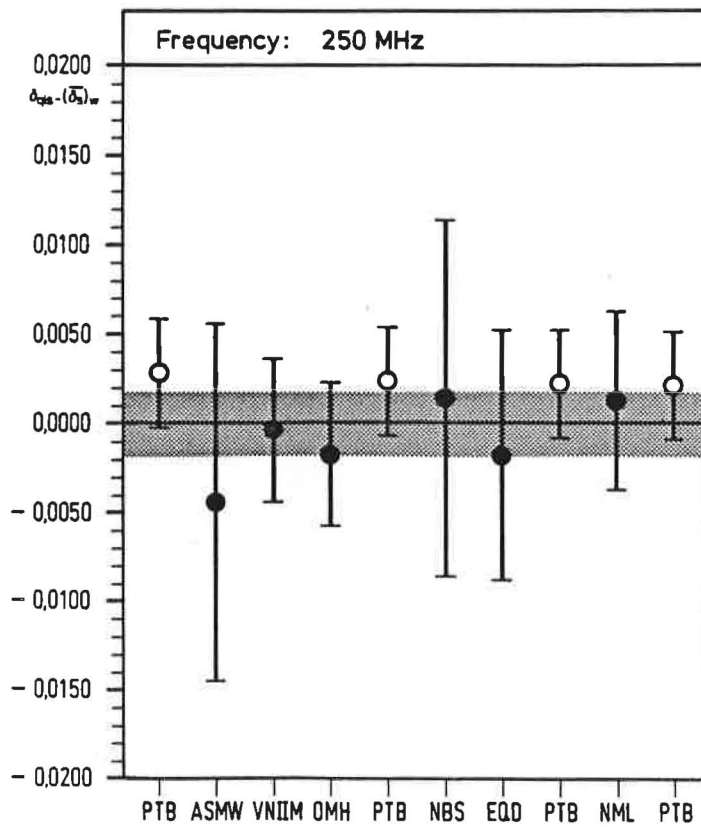

Fig. 10b

Transfer - Standard: PTB-III

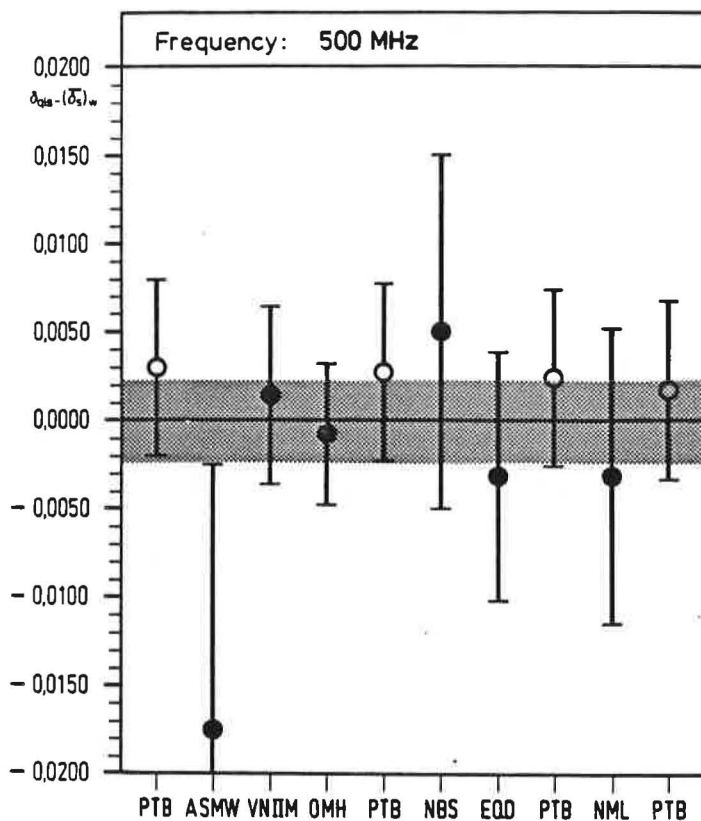

Fig. 10c

Transfer - Standard: PTB-III

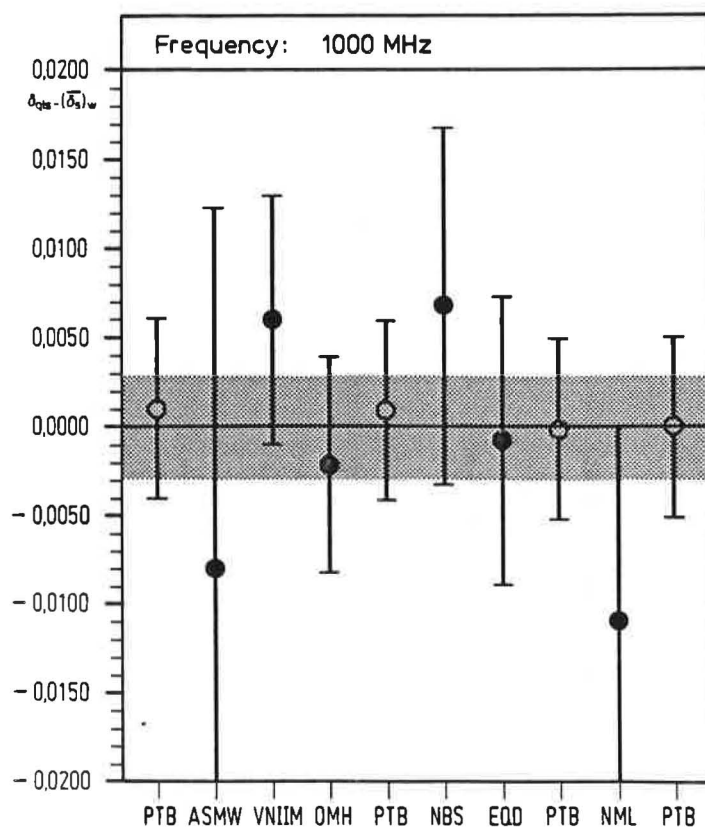

Fig. 10d

Transfer - Standard: OMH-I

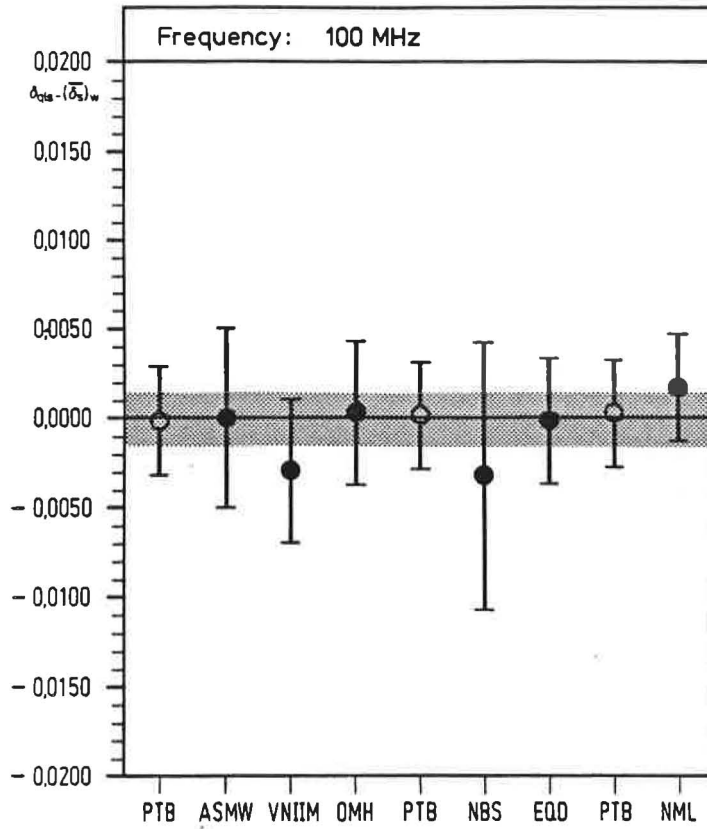

Fig. 11a

Transfer - Standard: OMH-I

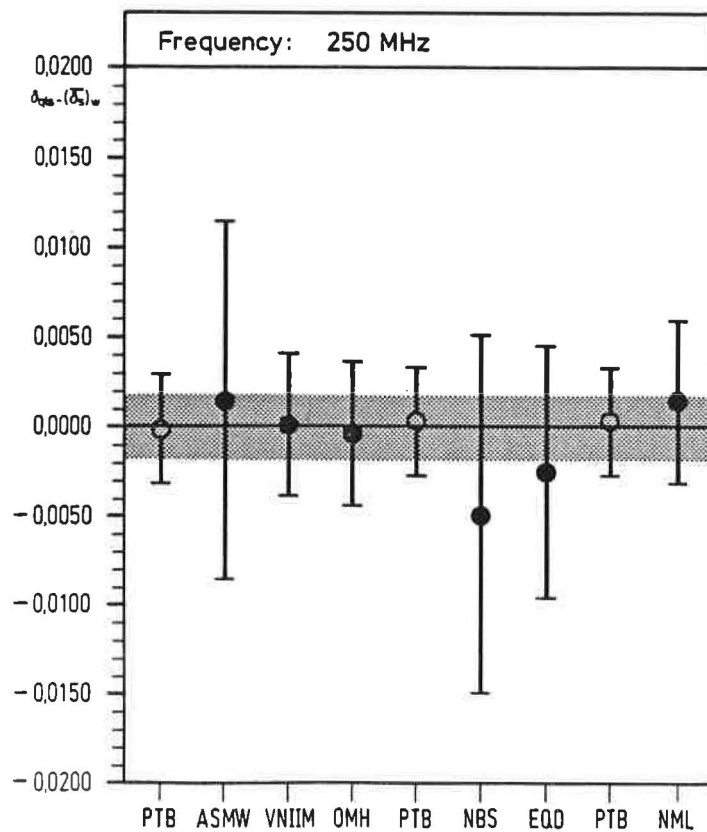

Fig. 11b

Transfer - Standard: OMH-I

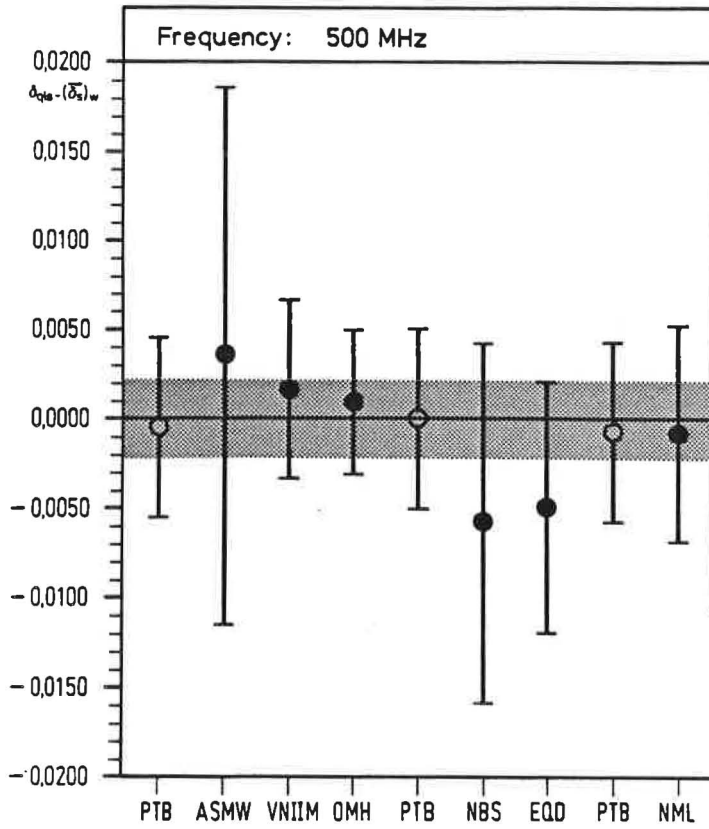

Fig. 11c

Transfer - Standard: OMH-I

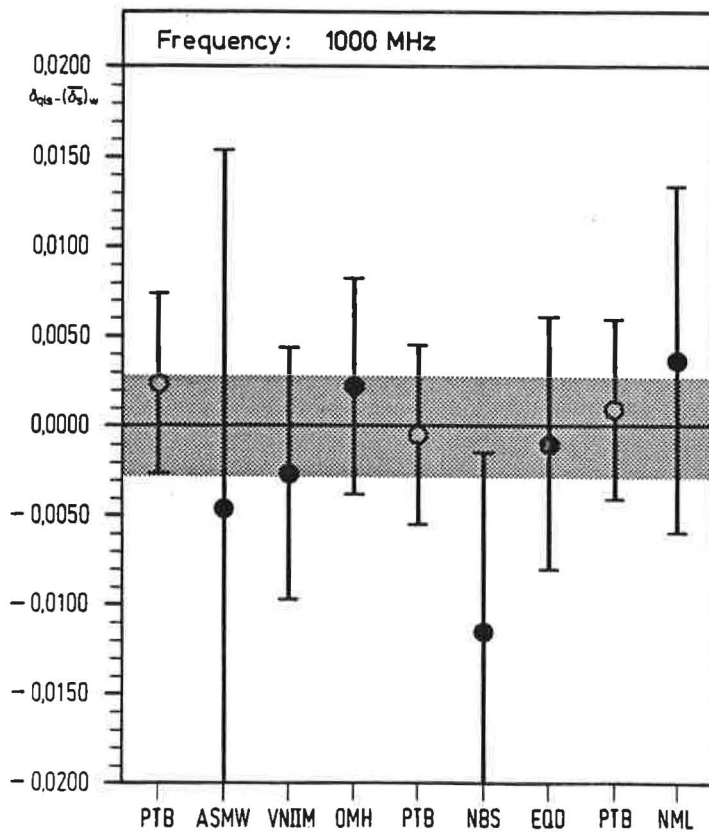

Fig. 11d



c) Mean deviations of the measuring devices from the most probable measurement value (weighted mean value)

It is, of course, not possible to completely separate the instabilities caused by fluctuations of the measuring devices and those of the transfer standards. But when considering the mean deviations of the measurement values averaged over all circulating standards for each participating laboratory and for each frequency value, the differences should be caused mainly by differences in the stability and systematic errors of the single devices.

The mean deviation of the measuring device 1 may then be defined by

$$|\overline{\Delta\delta_1}| = \frac{1}{p} \sum_{s=1}^p |\delta_{1s} - \overline{\delta_{sw}}| \quad (13)$$

p is the number of the circulating transfer standards, in this particular case, p = 4.

The mean systematic deviation of the device is then expressed by

$$\overline{\Delta\delta_1} = \frac{1}{p} \sum_{s=1}^p (\delta_{1s} - \overline{\delta_{sw}}) \quad (14)$$

Diagrams for both values (13) and (14) are given in Fig. 12 and 13.

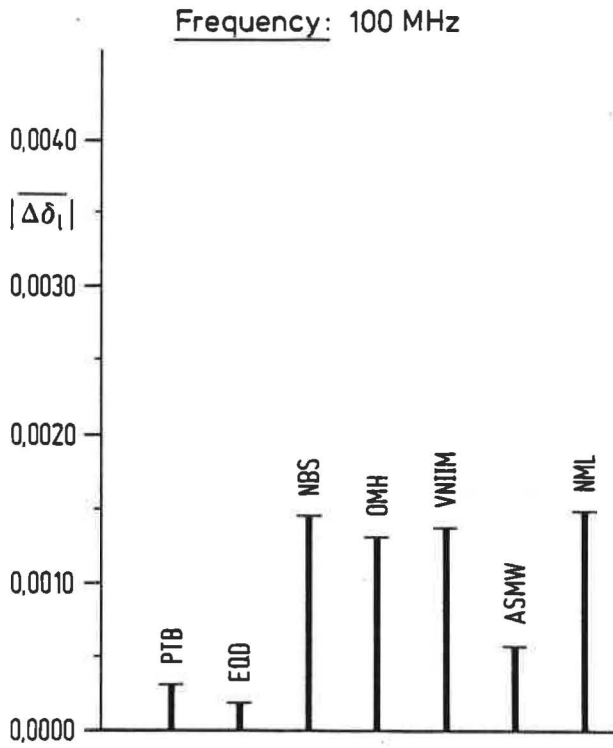

Fig. 12a

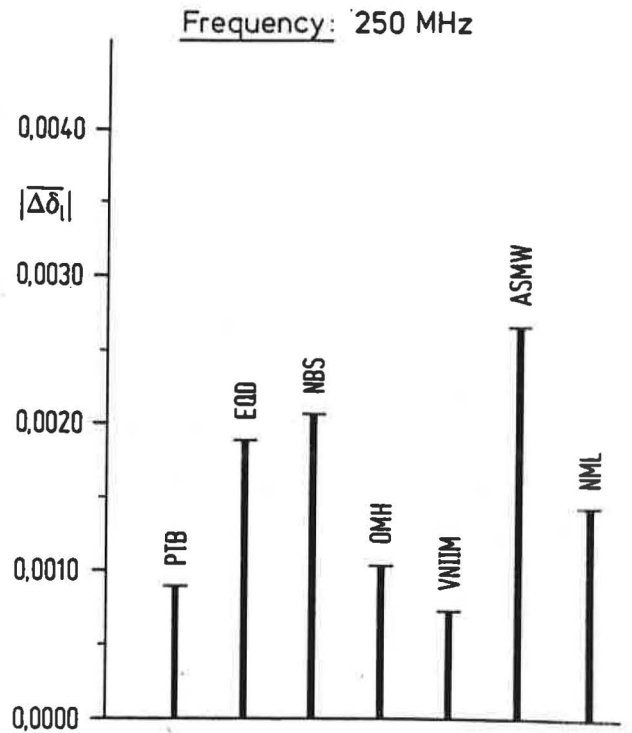

Fig. 12b

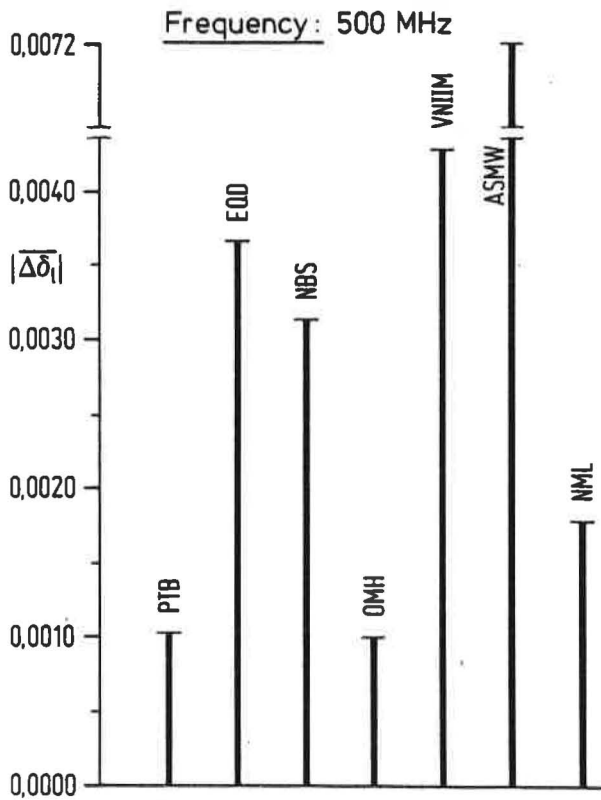

Fig. 12c

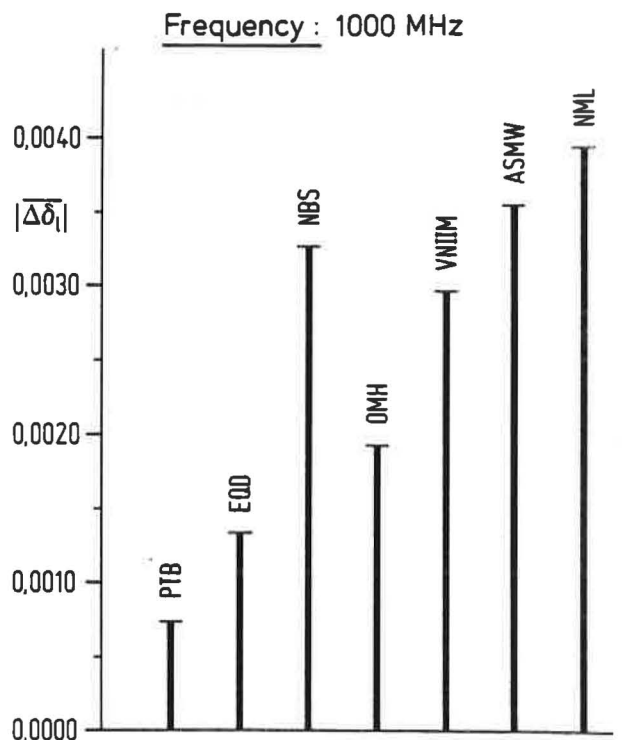

Fig. 12d

Fig. 12 Mean deviations of the measured values  $|\overline{\Delta\delta_1}|$  for the various measuring devices of the participating laboratories

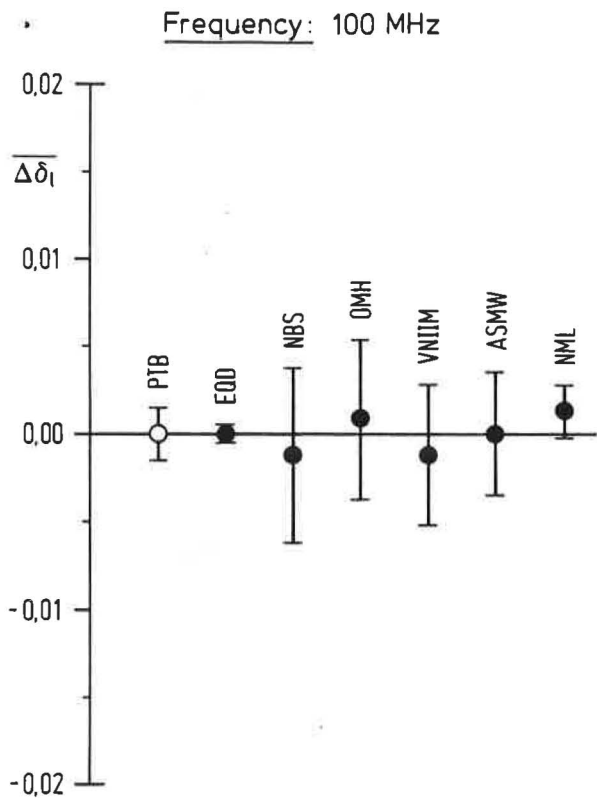

Fig. 13a

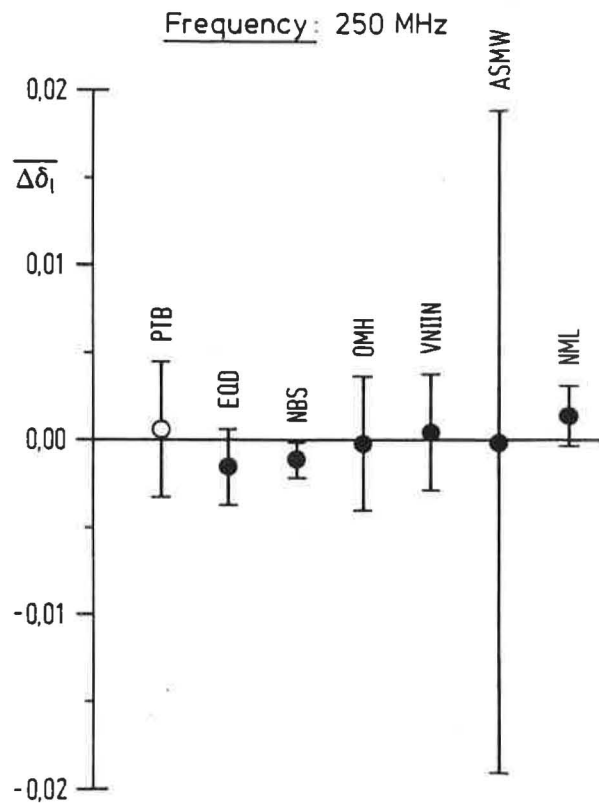

Fig. 13b

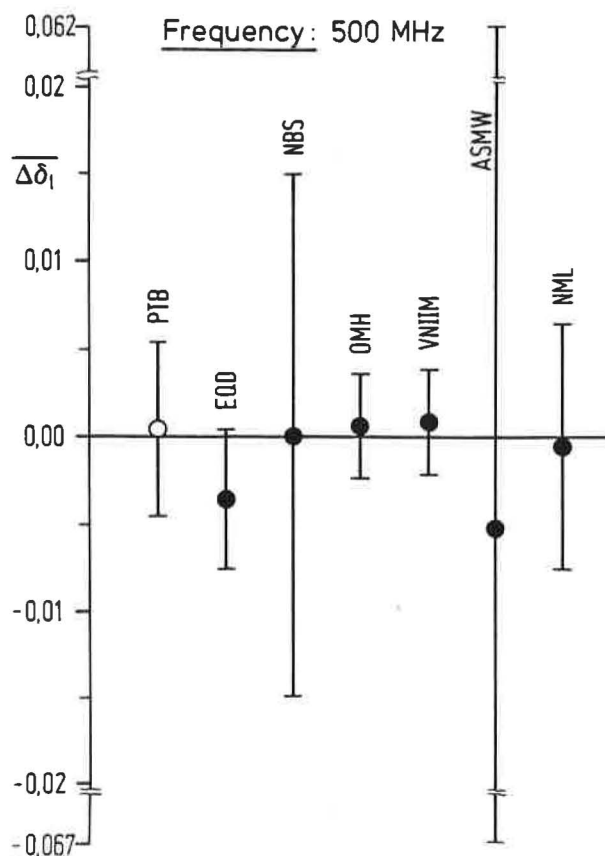

Fig. 13c

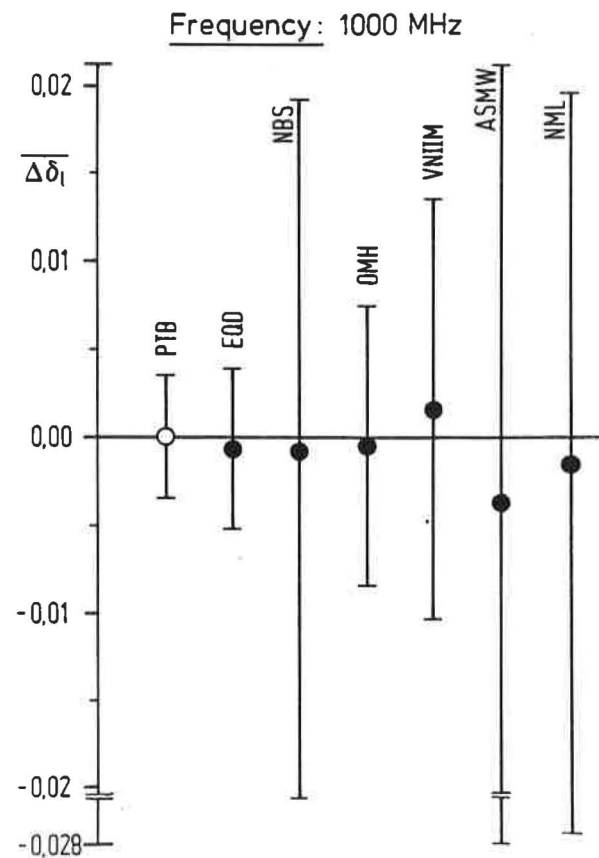

Fig. 13d

Fig. 13 Mean systematic deviations  $\Delta\delta_1$  for the various measuring devices of the participating laboratories, averaged over the measurement results on the 4 transfer standards including the uncertainties.

d) Mean deviations and long-term stability of the transfer standard

Differences in the stability of the circulating transfer standards may be recognized by comparing the expressions

$$|\overline{\Delta\delta_s}| = \frac{1}{m} \sum_{l=1}^m |\delta_{ls} - \bar{\delta}_{sw}| \quad (15)$$

averaged over the values measured by all participating laboratories for the circulating transfer standards (m being the number of laboratories, in our case m = 7, in one case m = 6). The diagrams are given in Fig. 14.

Assuming that the pilot laboratory's measuring device has no systematic drift and its random uncertainty is sufficiently small, a comparison of the pilot laboratory's succeeding measurement results on the same standard yields information on the long-term stability of the transfer standards

$$\Delta\delta_{ps,q} = \delta_{ps,q} - \delta_{ps,1} \quad (16)$$

(q = 1, 2, 3, 4)

These long-term deviations are given in Fig. 15.

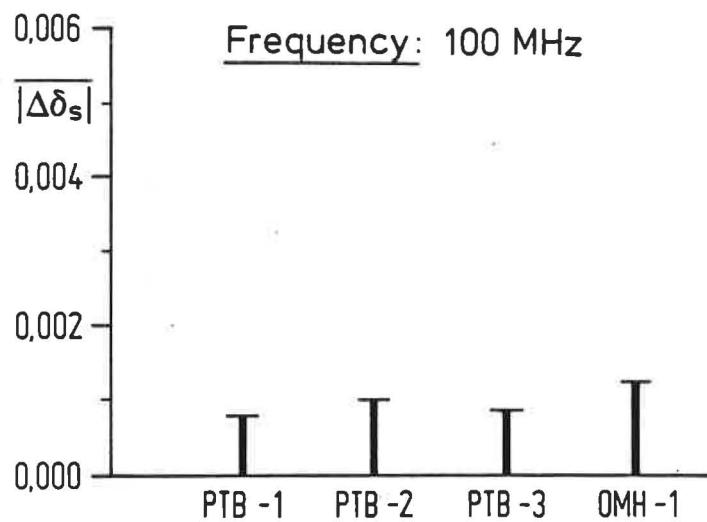

Fig. 14a

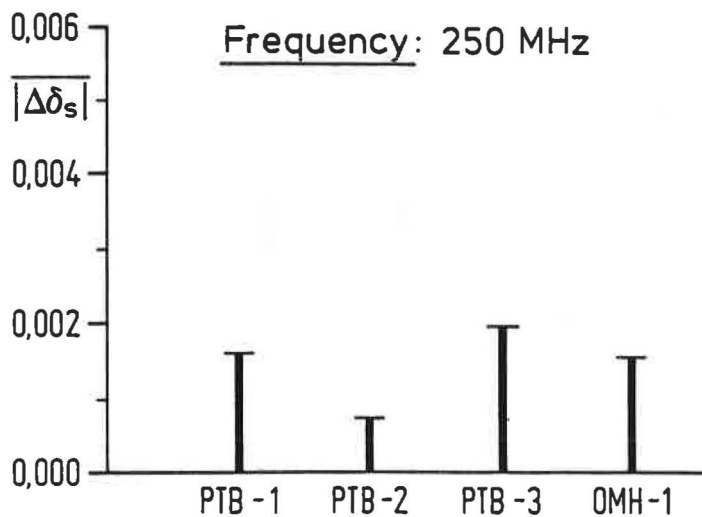

Fig. 14b

Fig. 14 Mean deviations  $|\overline{\Delta\delta_s}|$  for the four transfer standards averaged over the measurement values of all participating laboratories  
a) 100 MHz                      b) 250 MHz

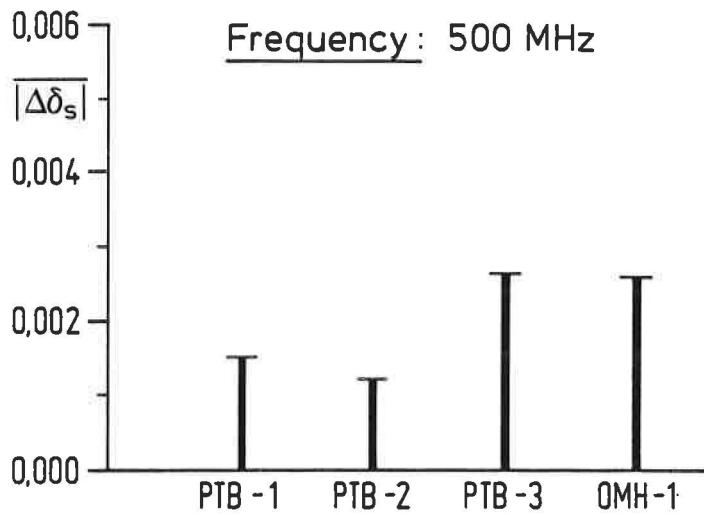

Fig. 14c

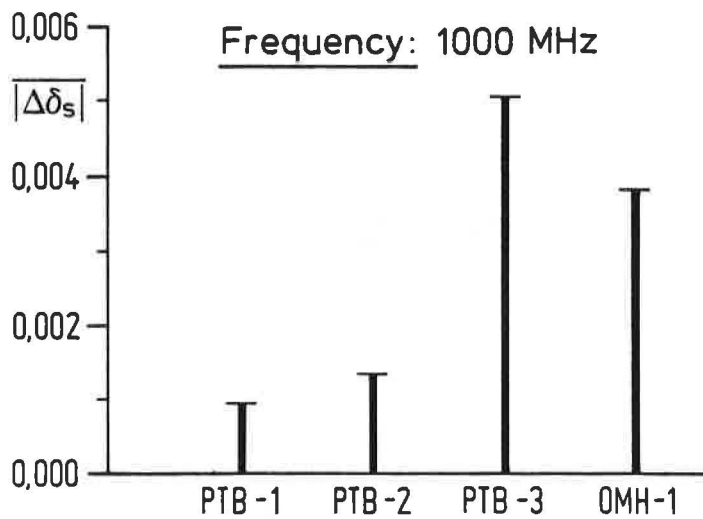

Fig. 14d

Fig. 14 Mean deviations  $|\overline{\Delta\delta_s}|$  for the four transfer standards averaged over the measurement values of all participating laboratories

c) 500 MHz

d) 1000 MHz

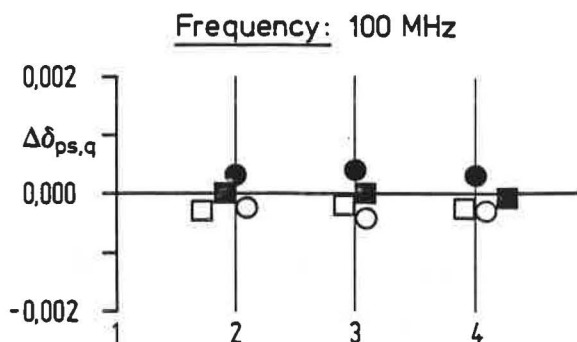

Fig. 15a

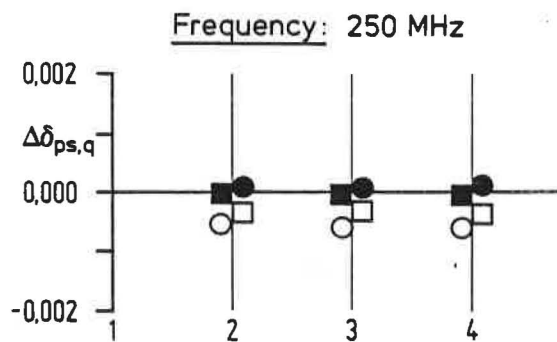

Fig. 15b

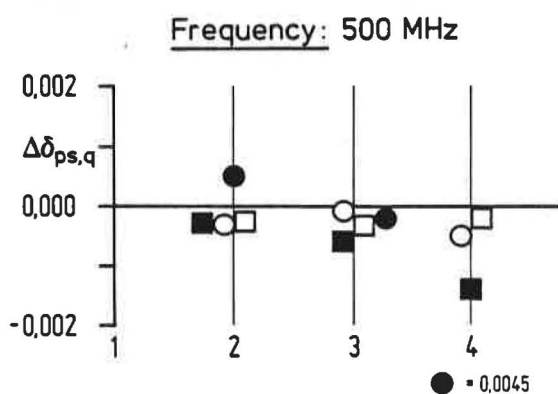

Fig. 15c

- PTB - I
- PTB - II
- PTB - III
- OMH - I

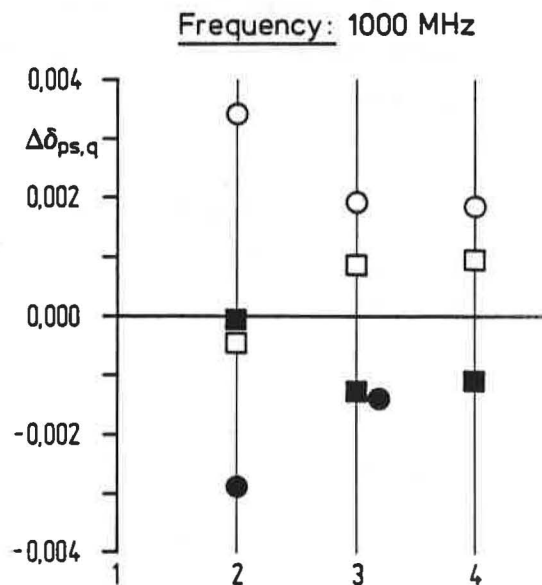

Fig. 15d

Fig. 15 Long-term deviations for the four transfer standards, calculated from the four controlling measurement values of the pilot laboratory (For each standard the difference of the three repeated measurement results from the first one is represented). The last (4.) measurements on transfer standard OMH-I were made after inserting a new thermocouple.

## 7. Conclusions

The numerous tables and diagrams representing the results and interpreting them from different points of views produce all the information in which the participants are interested.

A detailed discussion seems unnecessary; it should be left to each reader to draw his own conclusions. Only the following general points should be emphasized:

The measurement values of all participants are in good agreement with the uncertainties they themselves calculated. For the lower frequency ranges (100 MHz and 250 MHz), the deviations of the measured mean values from the most probable true measurement value (weighted mean value) are in many cases considerably smaller than the given limits of the uncertainty. No systematic deviations worth mentioning could be stated for any of the devices.

The deviations of the measured values from the weighted mean value increase with increasing frequency. With regard to the transfer standards the PTB-3 thermal converter - the only standard fitted with an N connector instead of a GR-900 connector - has larger deviations than the others.

The long-term stability - observed over a measuring period of 5 years - was good for all transfer standards. The drift of their measurement values was small compared with the total uncertainties of the measured values.

Thus this international intercomparison has shown a remarkably good agreement between the measurement values of RF voltage devices for the participating national institutes in all parts of the world.



REFERENCES:

Harris, I.A. : The Theory and Design of Coaxial Resistor Mounts for the Frequency Band 0 to 4000 MHz  
Proc. Inst. El, Eng, 103 C (1956), 1 - 10

Hermach, F.L. , Williams, E.S.: Thermal Voltage Converters for Accurate Voltage Measurements to 30 MHz  
Trans. AIEE (Communications and Electronics)79 (1960), 200-206

Hudson, P.A., Ondrejka, A.R.: Measurement Standards for Low and Medium Peak Pulse Voltages  
Journ. of Res. NBS 70C (1966), 13-18

Clark, R.F., Jurkus, A.P.: Calibration of Thermal Transfer Standards of RF Voltage  
IEEE Trans. on Instr. and Meas. IM-16 (1967), 232-237

Selby, M.C. : Bolometric Voltage and Current Standard for High and Microwave Frequencies  
Journ. of Res. NBS 72C (1968), 61-79

Federov, A.M. : Slide back voltmeters  
Izdatelstvo Standartov, Moscow, 1976

Aknaev, R.F., Federov, A.M., Galakhova, O.P., Krestovsky, V.V., Rozhdestvenskaya, T.B. : Standard Apparatus for the Volt Realization in the Frequency Range from 20 Hz to 1500 MHz  
IEEE Trans. on Instr. and Meas. IM 25 (1976) 538-541

Janik, D.: Voltage Accurate Measuring Methods - Results of an Experimental Comparison  
IEE Conf. Publ. No. 152, Euromas 1977, 27-28

Janik, D. Spannungsmessung im Frequenzbereich bis 1 GHz  
PTB- Bericht E-10 (1978), 127-139

APPENDIX 1

COMPLETE LISTS OF ALL MEASUREMENT RESULTS  
AS REPORTED BY THE PARTICIPATING LABORATORIES

2. Results for the measurement of the standard PTB-1 and PTB-2 in the EQD (England)

Calibrated by: A. A. Gross  
Checked by : G. R. Orford

VOLTAGE (1V) IN COAXIAL GUIDE SYSTEMS (50 Ω )  
AT 100 MHz, 250 MHz, 500 MHz, 1000 MHz

Pilot laboratory: PTB

(Comparison Cycle I)

Room temperature (°C)	: 21 ± 1
Room relative humidity (%)	: 40 ± 10 (PTB-1), 45 ± 10 (PTB-2)
Temperature of the water bath feeding the water-jackets of the standards (°C)	: 21 ± 1
Voltage (V)	: 0,9993 (PTB-1) 0,9996 (PTB-2)
Measuring method	: Comparison with a calibrated Rohde & Schwarz Power meter NRS acting as Master Reference Standard and COHU Model 355 DC Voltage Standard

Designation of the standard	P T B - 1 Reg. N <sup>o</sup> 2.22-2123-227/12, (Ser. No. 300208/ 50)				P T B - 2 Reg. N <sup>o</sup> 2.22-2123-227/15 (Ser. No. 300208/54)			
	100	250	500	1000	100	250	500	1000
Measuring frequency (MHz)	100	250	500	1000	100	250	500	1000
Number of measurements	10	10	10	10	11	11	11	11
Mean value of the RF/DC difference	+ 0.001 7	+ 0.002 0	- 0.000 4	- 0.004 7	+ 0.002 2	+ 0.002 9	+ 0.005 7	+ 0.008 1
Standard deviation	0.000 144	0.000 161	0.000 172	0.000 051	0.000 064	0.000 031	0.000 047	0.000 077
Standard deviation of mean	0.000 046	0.000 051	0.000 055	0.000 016	0.000 019	0.000 009	0.000 014	0.000 023
Minimum measured value	+ 0.001 54	+ 0.001 84	- 0.000 16	- 0.004 65	+ 0.002 14	+ 0.002 88	+ 0.005 65	+ 0.007 95
Maximum measured value	+ 0.001 93	+ 0.002 29	- 0.000 59	- 0.004 83	+ 0.002 36	+ 0.002 96	+ 0.005 83	+ 0.008 19
Estimated systematical uncertainty	0.004	0.004	0.004	0.004	0.004	0.004	0.004	0.004

Measuring period: January 1977

I. 1. Results for the 1. measurement of the standards PTB-1 and PTB-2 in the pilot-laboratory

(Measuring scientist:  
Dipl.-Ing. D. Janik)

VOLTAGE (1 V) IN COAXIAL GUIDE SYSTEMS  
AT 100 MHz, 250 MHz, 500 MHz, 1000 MHz

Pilot laboratory: PTB

(Comparison Cycle I)

Room temperature (°C)	:	23 ± 2
Room relative humidity (%)	:	45 ± 15
Temperature of the water bath feeding the water-jackets of the standards (°C)	:	23.00 ± 0.01
Voltage(V)	:	1.00 ± 0.03

Designation of the standard	P T B - 1 Reg. N <sup>o</sup> 2.22-2123-227/12, (Ser. No. 300208/50)				P T B - 2 Reg. N <sup>o</sup> 2.22-2123-227/15 (Ser. No. 300208/54)			
	100.00±0.01	250.00±0.01	500.00±0.01	1000.00±0.01	100.00±0.01	250.00±0.01	500.00±0.01	1000.00±0.01
Measuring frequency (MHz)	100.00±0.01	250.00±0.01	500.00±0.01	1000.00±0.01	100.00±0.01	250.00±0.01	500.00±0.01	1000.00±0.01
Number of measurements	3	3	3	3	3	3	3	3
Mean value of the RF/DC difference	+ 0.002 24	+ 0.003 79	+ 0.003 20	- 0.004 34	+ 0.002 26	+ 0.004 34	+ 0.008 34	+ 0.005 05
Standard deviation	0.000 03	0.000 10	0.000 13	0.000 86	0.000 07	0.000 05	0.000 07	0.000 87
Standard deviation of mean	0.000 02	0.000 06	0.000 07	0.000 50	0.000 04	0.000 03	0.000 04	0.000 50
Minimum measured value	+ 0.002 22	+ 0.003 68	+ 0.003 11	- 0.003 40	+ 0.002 18	+ 0.004 29	+ 0.008 26	+ 0.004 08
Maximum measured value	+ 0.002 28	+ 0.003 88	+ 0.003 35	- 0.005 08	+ 0.002 32	+ 0.004 39	+ 0.008 40	+ 0.005 76
Estimated systematical uncertainty	0.003	0.003	0.005	0.01	0.003	0.003	0.005 ,	0.01

VOLTAGE (1 V) IN COAXIAL GUIDE SYSTEMS  
AT 100 MHz, 250 MHz, 500 MHz and 1000 MHz  
 (Comparison Cycle I)

Pilot laboratory: PTB

I. 3. Results for the measurement  
of the standards PTB-1 and PTB-2  
in the NBS, Boulder, USA

Room temperature (°C) :	20°
Room relative humidity (%) :	40 %
Temperature of the water-bath feeding the water-jackets of the standards (°C) :	Room temperature
Voltage (V) :	0,9 V ≤ U ≤ 1,0 V
Measuring method :	Comparison with the NBS RF-voltage-standard

Designation of the Standard	P T B - 1 Reg. No. 2.22-2123-227/12 (Ser. No. 300 208/50)				P T B - 2 Reg. No. 2.22-2123-227/15 (Ser. No. 300 208/54)			
	100	250	500	1000	100	250	500	1000
Measuring frequency (MHz)	100	250	500	1000	100	250	500	1000
Number of measurements (n):	8	8	8	8	8	8	8	8
Mean value of the RF/DC difference	+ 0.001 1	+ 0.003 0	+ 0.003 6	- 0.002 5	+ 0.001 1	+ 0.003 4	+ 0.009 2	+ 0.008 3
Standard deviation s	0.000 040	0.000 134	0.000 074	0.000 236	0.000 111	0.000 180	0.000 422	0.000 780
Standard deviation of mean	0.000 014	0.000 047	0.000 026	0.000 083	0.000 039	0.000 064	0.000 149	0.000 276
Random error 3 s / √n	0.000 042	0.000 142	0.000 078	0.000 249	0.000 118	0.000 192	0.000 448	0.000 828
Minimum measured value	+ 0.001 04	+ 0.002 78	+ 0.003 48	- 0.002 18	+ 0.001 00	+ 0.003 13	+ 0.008 76	+ 0.007 56
Maximum measured value	+ 0.001 17	+ 0.003 18	+ 0.003 69	- 0.002 81	+ 0.001 36	+ 0.003 60	+ 0.009 67	+ 0.009 17
Estimated systematical uncertainty	0.007 5	0.01	0.01	0.01	0.007 5	0.01	0.01	0.01

Measuring period: January 1978

I. 4 Measuring results for the transfer-standards PTB-1 and PTB-2 measured in the pilot laboratory

AT 100 MHz, 250 MHz, 500 MHz, 1000 MHz

(Comparison Cycle I)

(Measuring scientist:  
Dipl.-Ing. D. Janik)

Room temperature (°C)	:	21 ± 1
Room relative humidity (%)	:	50 ± 10
Temperature of the water bath feeding the water-jackets of the standards (°C)	:	22 ± 0.02
Voltage (V)	:	1.00 ± 0.01

Designation of the standard	P T B - 1 Reg.N <sup>o</sup> 2.22-2123-227/12 (Ser. No. 300208/50)				P T B - 2 Reg.N <sup>o</sup> 2.22-2123-227/15 (Ser. No. 300208/54)			
	100.00±0.01	250.00±0.01	500.00±0.01	1000.00±0.01	100.00±0.01	250.00±0.01	500.00±0.01	1000.00±0.01
Measuring frequency (MHz)	100.00±0.01	250.00±0.01	500.00±0.01	1000.00±0.01	100.00±0.01	250.00±0.01	500.00±0.01	1000.00±0.01
Number of measurements	6	6	6	6	6	6	6	6
Mean value of the RF/DC difference	+ 0.001 95	+ 0.003 44	+ 0.002 94	- 0.004 80	+ 0.002 00	+ 0.003 78	+ 0.008 02	+ 0.008 44
Standard deviation	0.000 12	0.000 08	0.000 22	0.000 08	0.000 09	0.000 06	0.000 10	0.000 49
Standard deviation of mean	0.000 05	0.000 03	0.000 09	0.000 03	0.000 04	0.000 03	0.000 04	0.000 20
Minimum measured value	+ 0.001 92	+ 0.003 34	+ 0.002 69	- 0.004 94	+ 0.001 89	+ 0.003 71	+ 0.007 90	+ 0.008 01
Maximum measured value	+ 0.002 05	+ 0.003 54	+ 0.003 24	- 0.004 73	+ 0.002 15	+ 0.003 88	+ 0.008 18	+ 0.009 22
Estimated systematic uncertainty	0.003	0.003	0.005	0.005	0.003	0.003	0.005	0.005

Measuring period: June 1978

I.5 Measuring results for the transfer standards PTB-1 and PTB-2, measured in OMH (Hungary)

VOLTAGE (1 V) IN COAXIAL GUIDE SYSTEMS

Pilot laboratory: PTB

AT  
100 MHz, 250 MHz, 500 MHz and 1000 MHz

ROOM TEMPERATURE (°C)	: 24 ± 2
ROOM RELATIVE HUMIDITY (%)	: 50 ± 10
TEMPERATURE OF THE WATER-BATH FEEDING THE WATER-JACKETS OF THE STANDARDS (°C)	: = 24
VOLTAGE (V)	: 1 ± 0.02

Designation of the standard	PTB - 1				PTB - 2			
	Reg.No. 2.22 - 2123 - 227/12 Ser.No. 300208/50							
Measuring frequency (MHz)	100	250	500	1000	100	250	500	1000
Number of measurements	10	6	4	6	10	8	10	10
Mean value of the RF/DC difference	+ 0.0045	+ 0.0059	+ 0.0048	- 0.0017	+ 0.0044	+ 0.0034	+ 0.0091	+ 0.0043
Standard deviation	0.000657	0.000524	0.000633	0.001067	0.000725	0.000264	0.000445	0.001775
Standard deviation of mean	0.000208	0.000214	0.000316	0.000435	0.000229	0.000093	0.000141	0.000562
Minimum measured value	+ 0.0034	+ 0.0052	+ 0.0040	- 0.0024	+ 0.0031	+ 0.0030	+ 0.0082	+ 0.0012
Maximum measured value	+ 0.0053	+ 0.0066	+ 0.0054	0.0000	+ 0.0054	+ 0.0037	+ 0.0096	+ 0.0067
Estimated systematical uncertainty	± 0.004	± 0.004	± 0.004	± 0.006	± 0.004	± 0.004	± 0.004	± 0.006

Measuring period: Nov./Dec. 1978

I. 6 Measuring results for the transfer-standards

PTB-1 and PTB-2 measured in the VNIIM (USSR)

VOLTAGE (1 V) IN COAXIAL GUIDE SYSTEMS

AT 100 MHz, 250 MHz, 500 MHz AND 1000 MHz

Pilot laboratory: PTB

GT - RF 75-A5

(CYCLE I)

Measuring methods A Diode compensating voltmeter with diode measuring transducer, calibrated by the national AC voltage standard; special triplex connection to the transfer-standard  
 B Absorbing power wattmeter (thermistor receiving transducer, thermo-resistor bridge, special triplex connection to the transfer-standard  
 C Direct connection between a power passing wattmeter (thermistor-coupler) and the transfer-standard

Designation of the standard	PTB - 1				PTB - 2				
	Reg.No. 2.22 - 2123 - 227/12 Ser.No. 300208/50				Reg.No. 2.22 - 2123 - 227/15 Ser.No. 300208/54				
Measuring frequency (MHz)	100	250	500	1000	100	250	500	1000	
Number of measurements	≤ 10	≤ 10	≤ 10	≤ 10	≤ 10	≤ 10	≤ 10	≤ 10	
Mean value of RF/DC difference	A	+ 0.0018	+ 0.0038	+ 0.0025	- 0.0035	+ 0.0033	+ 0.0072	+ 0.0070	+ 0.0018
	B	+ 0.0027	+ 0.0047	+ 0.0041	- 0.0027	- 0.0012	+ 0.0042	+ 0.0081	+ 0.0062
	C	-	+ 0.0033	+ 0.0062	- 0.0005	-	-	-	-
Mean value of the methods applied		+ 0.0022	+ 0.0039	+ 0.0043	- 0.0022	+ 0.0010	+ 0.0057	+ 0.0075	+ 0.0040
Standard deviation $s_0$	A	0.0005	0.0005	0.0010	0.0010	0.0005	0.0005	0.0010	0.0010
	B	0.0008	0.0005	0.0007	0.0008	0.0008	0.0005	0.0007	0.0008
	C	-	0.0007	0.0009	0.0012	-	0.0007	0.0009	0.0012
Estimated systematical uncertainty	A	0.0015	0.0020	0.0025	0.0040	0.0015	0.0020	0.0025	0.0040
	B	0.0020	0.0020	0.0020	0.0030	0.0020	0.0020	0.0020	0.0030
	C	-	0.0030	0.0030	0.0050	-	0.0030	0.0030	0.0050
Total uncertainty + 3 $s_0$	A	0.0030	0.0035	0.0055	0.0070	0.0030	0.0035	0.0055	0.0070
	B	0.0045	0.0035	0.0040	0.0055	0.0045	0.0035	0.0040	0.0055
	C	-	0.0050	0.0060	0.0090	-	0.0050	0.0060	0.0090

Measuring period: 1980



I. 7 Measuring results for the transfer-standards

PTB-1 and PTB-2 measured in the ASMW (DDR)

VOLTAGE (1V) IN COAXIAL GUIDE SYSTEMS

AT 100 MHz, 250 MHz, 500 MHz AND 1000 MHz

GT - RF 75A-5

(cycle I)

Pilot laboratory: PTB

Room temperature (°C)	: 22 ± 1
Room relative humidity (%)	: not given
Temperature of the water bath feeding the water-jackets of the standards (°C)	-
Voltage (V)	: DC value: 1.0000 ± 0.0001

Designation of the standard	Reg. No. 2.22 - 2123 - 227/12 Ser.No. 300 208/50				Reg.No. 2.22-2123-227/15 Ser.No.: 300208/54
Measuring frequency (MHz)	100.00 ± 0.01	250.00 ± 0.025	500.00 ± 0.05	1000.0 ± 0.1	Measurements on transfer-standards fitted with GR 900/75 Ω connectors are not possible presently.
Number of measurements	10 ≤ n ≤ 15				
Mean value of the RF/DC difference	+ 0.0018	+ 0.0065	+ 0.0027	- 0.0011	
Standard deviation	-	-	-	-	
Standard deviation of the mean	≤ 0.0007				
Estimated systematical uncertainty	± 0.004	± 0.006	± 0.009	± 0.013	

Measuring period: Nov. 1980 - Febr. 1981

I.8 Measuring results for the transfer-standards PTB-1 and PTB-2, measured in PTB

VOLTAGE (1V) IN COAXIAL GUIDE SYSTEMS  
AT 100 MHz, 250 MHz, 500 MHz, 1000 MHz  
GT - RF 75-A5  
(COMPARISON CYCLE I)

Pilot laboratory: PTB

ROOM TEMPERATURE (°C)	: 21 ± 1
ROOM RELATIVE HUMIDITY (%)	: 50 ± 10
TEMPERATURE OF THE WATER-BATH FEEDING THE WATER JACKETS OF THE STANDARDS (°C)	: 22 ± 0.02
RELATIVE UNCERTAINTY OF THE FREQUENCY (MHz)	: < 0.0001
VOLTAGE (V)	: 1.00 ± 0.01

Designation of the standard	PTB - 1				PTB - 2			
	Reg.No. 2.22 - 2123 - 227/12, (Ser.No. 300208/50)				Reg.No. 2.22 - 2123 - 227/15, (Ser.No. 300208/54)			
Measuring frequency (MHz)	100.00±0.01	250.00±0.01	500.00±0.01	1000.00±0.01	100.00±0.01	250.00±0.01	500.00±0.01	1000.00±0.01
Number of measurements	6	6	6	6	6	6	6	6
Mean value of RF/DC difference	+ 0.00203	+ 0.00346	+ 0.00287	- 0.00350	+ 0.00185	+ 0.00375	+ 0.00825	+ 0.00697
Standard deviation	0.00010	0.00017	0.00025	0.00014	0.00003	0.00017	0.00037	0.00011
Standard deviation of the mean	0.00004	0.00007	0.0001	0.0001	0.00001	0.00007	0.00015	0.00005
Maximum measured value	+ 0.00214	+ 0.00364	+ 0.00318	- 0.00338	+ 0.00189	+ 0.00404	+ 0.00894	+ 0.00708
Minimum measured value	+ 0.00189	+ 0.00327	+ 0.00256	- 0.00375	+ 0.00179	+ 0.00354	+ 0.00785	+ 0.00678
Estimated systematic uncertainty	0.003	0.003	0.005	0.005	0.003	0.003	0.005	0.005

Measuring period: May 1981

I. 9 Results of the measurements for the transfer standards PTB-1 and PTB-2 in NML (Australia)

VOLTAGE (1 V) IN COAXIAL GUIDE SYSTEMS  
at 100 MHz, 250 MHz, 500 MHz, 1000 MHz  
GT-RF 75 A-5  
(Comparison cycle I)

Pilot laboratory: PTB

ROOM RELATIVE TEMPERATURE (°C) :	21.5 ± 0.5
ROOM RELATIVE HUMIDITY (%) :	55 ± 5
TEMPERATURE OF THE WATER-BATH FEEDING THE WATER JACKETS OF THE STANDARDS (°C) :	21,5 ± 0.05
RELATIVE UNCERTAINTY OF THE FREQUENCY f :	± 1 · 10 <sup>-5</sup>
VOLTAGE (V) :	0.9995 ± 0.0005

Designation of the standard	PTB - 1				PTB - 2			
	Reg.No. 2.22-2123-227/12 (Ser.Nr.300208/50)				Reg.No. 2.22-2123-227/15 (Ser.Nr. 300208/54)			
Measuring frequency (MHz)	100	250	500	1000	100	250	500	1000
Number of sets of measurements	1	1	2	8	2	3	2	3
Number of measurements for each set	8	4	4	8	8	6	4	5
Total number of measurements	8	4	8	64	16	18	8	15
Mean value of RF/DC difference	0.0033	0.0068	0.0064	- 0.002	0.0033	0.0042	0.007	0.007
Standard deviation (sets combined)	0.000019	0.00001	0.000031	0.000071	0.00007	0.00039	0.00066	0.000065
Standard deviation of the mean (sets combined)	0.000007	0.000006	0.000012	0.000009	0.000018	0.00095	0.00025	0.000017
Minimum measured value	0.00323	0.00676	0.00631	- 0.00206	0.00317	0.00368	0.00637	0.00687
Maximum measured value	0.00328	0.00678	0.00641	- 0.00184	0.00340	0.00471	0.00763	0.00707
Estimated systematical uncertainty (99%)	± 0.003	± 0.0045	± 0.0061	± 0.0097	± 0.003	± 0.0045	± 0.0061	± 0.0097

Measuring period: August to December 1981

I. 10 Measuring results for the transfer standards PTB-1 and PTB-2, measured in PTB (last measurement)

VOLTAGE (1V) IN COAXIAL GUIDE SYSTEMS

Pilot laboratory: PTB

AT

100 MHz, 250 MHz, 500 MHz and 1000 MHz

GT-RF 75 A-5

(Comparison cycle I)

ROOM TEMPERATURE ( $^{\circ}\text{C}$ )	: 21 + 1
ROOM RELATIVE HUMIDITY (%)	: 50 + 10
TEMPERATURE OF THE WATER-BATH FEEDING THE WATER JACKETS OF THE STANDARDS ( $^{\circ}\text{C}$ )	: 22 + 0.02
RELATIVE UNCERTAINTY OF THE FREQUENCY	: $\leq 1 \cdot 10^{-4}$
VOLTAGE (V)	: 1.00 + 0.01

Designation of the standard	PTB - 1				PTB - 2			
	Reg.No. 2.22-2123-227/12, Ser.No. 300208/50				Reg.No. 2.22-2123-227/15, Ser.No. 300208/54			
Measuring frequency (MHz)	100	250	500	1000	100	250	500	1000
Number of measurements	6	6	6	6	6	6	6	6
Mean value of RF/DC difference	+ 0.00199	+ 0.00341	+ 0.00299	- 0.00340	+ 0.00196	+ 0.00371	+ 0.00785	+ 0.00689
Standard deviation	0.00008	0.00013	0.00023	0.00043	0.00010	0.00016	0.0003	0.00015
Standard deviation of mean	0.00003	0.00005	0.00009	0.00018	0.00004	0.00006	0.00012	0.00006
Maximum measured value	+ 0.00208	+ 0.00354	+ 0.00327	- 0.00295	+ 0.00209	+ 0.00392	+ 0.00817	+ 0.00707
Minimum measured value	+ 0.00190	+ 0.00321	+ 0.00264	- 0.00403	+ 0.00184	+ 0.00362	+ 0.00362	+ 0.00668
Estimated systematical uncertainty	0.003	0.003	0.005	0.005	0.003	0.003	0.005	0.005

Measuring period: March 1982

II.1 Measuring results for  
the Standard OMH-1, measured  
in its own laboratory

VOLTAGE (1 V) IN COAXIAL GUIDE SYSTEMS  
AT 100 MHz, 250 MHz, 500 MHz, 1000 MHz

Pilot laboratory:  
P T B

(Comparison cycle II)

Room temperature (°C)	:	25 ± 3
Room relative humidity (%)	:	70 ± 5
Temperature of the water bath feeding the water-jackets of the standards (°C)	:	-
Voltage (V) 100 MHz-250 MHz-500 MHz:		0,78 V ... 1,0 V
		1000 MHz: 0,52 V ... 1,0 V

Designation of the standard	OMH-1, Reg. No. 76001, Inv. No. 1456			
Measuring frequency (MHz)	100.00±0.01	250.000±0.025	500.00±0.05	1000.0±0.1
Number of measurements	3	3	3	6
Mean value of RF/DC difference	+ 0.003 14	+ 0.0228	+ 0.0084	+ 0.092.
Standard deviation	-	-	-	0.0022
Standard deviation of mean	-	-	-	0.001
Minimum measured value	-	-	-	+ 0.0934
Maximum measured value	-	-	-	+ 0.0876
Estimated systematical uncertainty	0.005	0.005	0.005	0.01

Measuring period: September 1976

II.2 Measuring results for the transfer-standards OMH-1 and PTB-3, measured in the pilot laboratory

VOLTAGE (1 V) IN COAXIAL GUIDE SYSTEMS  
AT 100 MHz, 250 MHz, 500 MHz, 1000 MHz  
 (Comparison Cycle II)

Pilot laboratory: P T B

Room temperature (°C)	:	21 ± 1
Room relative humidity (%)	:	50 ± 10
Temperature of the water bath feeding the water-jackets of the standards (°C)	:	22 ± 0.02
Voltage (V)	:	1,0 V

Designation of the standard	P T B - 3 (Ser. No. 125) Reg. No.: 2.22-2125-392/156				O M H - 1 Reg. No. - 76001			
	100.00 ± 0.01	250.00 ± 0.01	500.00 ± 0.01	1000.00 ± 0.01	100.00 ± 0.01	250.00 ± 0.01	500.00 ± 0.01	1000.00 ± 0.01
Measuring frequency (MHz)	100.00 ± 0.01	250.00 ± 0.01	500.00 ± 0.01	1000.00 ± 0.01	100.00 ± 0.01	250.00 ± 0.01	500.00 ± 0.01	1000.00 ± 0.01
Number of measurements	12	12	12	12	12	12	12	12
Mean value of the RF/DC difference	+ 0.0110	+ 0.0563	+ 0.1196	- 0.2079	+ 0.0068	+ 0.0284	+ 0.0188	+ 0.1171
Standard deviation	0.0002	0.0002	0.0003	0.0005	0.0001	0.0002	0.0003	0.0004
Standard deviation of mean	0.0001	0.0001	0.0001	0.0002	0.0001	0.0001	0.0001	0.0001
Minimum measured value	+ 0.0106	+ 0.0559	+ 0.1192	- 0.2084	+ 0.006 77	+ 0.0281	+ 0.0184	+ 0.1164
Maximum measured value	+ 0.0112	+ 0.0565	+ 0.1201	- 0.2072	+ 0.006 83	+ 0.0286	+ 0.0191	+ 0.1174
Estimated systematical uncertainty	0.003	0.003	0.005	0.005	0.003	0.003	0.005	0.005

Measuring period: October 1977

VOLTAGE (1 V) IN COAXIAL GUIDE SYSTEMS  
AT 100 MHz, 250 MHz, 500 MHz and 1000 MHz

II.3 Measuring results  
for the transfer-standards

ETB-3 and OMH-1, measured  
in ASMW (DDR)

(Comparison Cycle II)

Room temperature (°C) :	22 ± 1
Room relative humidity (%)	-
Temperature of the water-bath, feeding the water jackets of the standards: (°C):	-
Relative uncertainty of the frequency:	≅ 1 · 10 <sup>-4</sup>
Voltage (V)	1.0000 ± 0.0001

Designation of the standard:	P T B - 3				O M H - 1			
	Reg. No. 2.22-2125-392/156; Ser. No. 125				Reg. No. 76001 -----			
Measuring frequency (MHz)	100	250	500	1000	100	250	500	1000
Number of measurements (n)	in all cases: 10 ≅ n ≅ 15				in all cases 10 ≅ n ≅ 15			
Mean value of RF/DC difference:	+0.009	+0.049	+0.098	-0.217	+0.007	+0.030	+0.023	+0.110
Standard deviation:	≅ 0.0003	≅ 0.0003	≅ 0.0003	≅ 0.0003	≅ 0.0003	≅ 0.0003	≅ 0.0003	≅ 0.0003
Standard deviation of mean:	-	-	-	-	-	-	-	-
Maximum measured value :	-	-	-	-	-	-	-	-
Minimum measured value:	-	-	-	-	-	-	-	-
Estimated systematical uncertainty	0.005 ≅ $\left  \frac{\Delta U}{U} \right  \equiv 0.02$ increasing with frequency				0.005 ≅ $\left  \frac{\Delta U}{U} \right  \equiv 0.02$ increasing with frequency			

Measuring method: Comparison with the ASMW-standard device, applying the principle of thermal power measurement.

Measuring period: January 1978

II.4 Measuring results for the transfer standards PTB-3 and OMH-1, measured in IMM (USSR)

VOLTAGE (V) IN COAXIAL GUIDE SYSTEMS

Pilot laboratory: PTB

AT

100 MHz, 150 MHz, 250 MHz, 500 MHz and 1000 MHz

(Comparison cycle II)

ROOM TEMPERATURE (°C)	:	NO SPECIFICATIONS
ROOM RELATIVE HUMIDITY (%)	:	NO SPECIFICATIONS
TEMPERATURE OF THE WATER-BATH FEEDING THE WATER-JACKETS OF THE STANDARDS (°C)	:	NO SPECIFICATIONS
VOLTAGE (V)	:	NO SPECIFICATIONS

Designation of the standards	PTB - 3 Reg.No. 2.22 - 2125 - 392/156 Ser.No. 125					OMH - 1 Reg. No. 76001					
	100	150	250	500	1000	100	150	250	500	1000	
Measuring frequency (MHz)	100	150	250	500	1000	100	150	250	500	1000	
Mean value of the <sup>x</sup> RF/DC difference	Method a <sup>xx</sup>	-	+ 0.023	+ 0.053	-	-	-	+ 0.014	+ 0.029	-	-
	Method b	+ 0.009	+ 0.020	+ 0.053	+ 0.118	- 0.203	+ 0.004	+ 0.012	+ 0.028	+ 0.021	+ 0.112

<sup>x</sup>Further dates of uncertainty were not given.

<sup>xx</sup>

Method a: Using a diode compensated voltmeter, calibrated by using the USSR special state standard of AC voltage from 100 MHz to 1000 MHz.

Method b: Using the USSR special state standard of power in coaxial lines.

Measuring period: autumn 1978



II.5 Measuring results for the transfer standards PTB-3 and OMH-1, measured in OMH (Hungary)

VOLTAGE (1V) IN COAXIAL GUIDE SYSTEMS

Pilot laboratory: PTB

AT

100 MHz, 250 MHz, 500 MHz and 1000 MHz

ROOM TEMPERATURE (°C)	: 24 ± 2
ROOM RELATIVE HUMIDITY (%)	: 50 ± 10
TEMPERATURE OF THE WATER-BATH FEEDING THE WATER-JACKETS OF THE STANDARDS (°C)	: = 24
VOLTAGE (V)	: 1 ± 0.05

Designation of the standard	PTB - 3 Reg.No. 2.22 - 2125 - 392/156 Ser.No. 125				OMH - 1 Reg.No. 76001			
	100	250	500	1000	100	250	500	1000
Measuring frequency (MHz)	100	250	500	1000	100	250	500	1000
Number of measurements	10	10	10	14	10	10	10	10
Mean value of the RF/DC difference	+ 0.0098	+ 0.0516	+ 0.1157	- 0.2111	+ 0.0073	+ 0.0281	+ 0.0203	+ 0.1169
Standard deviation	0.000245	0.000189	0.000285	0.000592	0.000152	0.000565	0.000381	0.000171
Standard deviation of mean	0.0000775	0.0000597	0.0000901	0.0001583	0.0000482	0.0001788	0.0001207	0.0000540
Minimum measured value	+ 0.0093	+ 0.0514	+ 0.1153	- 0.2123	+ 0.0070	+ 0.0270	+ 0.0195	+ 0.1167
Maximum measured value	+ 0.0101	+ 0.0518	+ 0.1161	- 0.2101	+ 0.0075	+ 0.0287	+ 0.0208	+ 0.1171
Estimated systematical uncertainty	± 0.004	± 0.004	± 0.004	± 0.006	± 0.004	± 0.004	± 0.004	± 0.006

Measuring period: Jan./Febr. 1979

II. 6. Measurement results for  
the transfer-standards  
PTB-3 and OMH-1, (1.  
re-measurement in the pilot-  
laboratory, PTB)

VOLTAGE ( 1 V ) IN COAXIAL GUIDE SYSTEMS

Pilot laboratory: PTB

AT 100 MHz, 250 MHz, 500 MHz, 1000 MHz

( COMPARISON CYCLE II )

Room temperature ( °C )	:	21 ± 1
Room relative humidity ( % )	:	50 ± 10
Temperature of the water-bath feeding the water-jackets of the standards ( °C )	:	-
Relative uncertainty of the frequency	:	1.10 <sup>-4</sup>
Voltage ( V )	:	1.0 V

Designation of the standard	PTB - 3 Reg.No. 2.22 - 2125 - 392/156, Ser.No. 125 *				OMH - 1 Reg. No. 76001			
	100.00 ± 0.01	250.00 ± 0.01	500.00 ± 0.01	1000.00 ± 0.01	100.00 ± 0.01	250.00 ± 0.01	500.00 ± 0.01	1000.00 ± 0.01
Measuring frequency (MHz)	100.00 ± 0.01	250.00 ± 0.01	500.00 ± 0.01	1000.00 ± 0.01	100.00 ± 0.01	250.00 ± 0.01	500.00 ± 0.01	1000.00 ± 0.01
Number of measurements	6	6	6	6	6	6	6	6
Mean value of RF/DC difference	+ 0.0110	+ 0.0558	+ 0.1193	- 0.2080	+ 0.0071	+ 0.0289	+ 0.0193	+ 0.1142
Standard deviation	0.00011	0.00022	0.00022	0.00043	0.00006	0.00015	0.00020	0.00034
Standard deviation of the mean	0.00003	0.00006	0.00006	0.00012	0.00002	0.00004	0.00006	0.0001
Maximum measured value	0.01124	0.05622	0.11971	- 0.20712	0.00713	0.02907	0.01958	0.11474
Minimum measured value	0.01082	0.05559	0.11901	- 0.20857	0.00697	0.02865	0.01895	0.11368
Estimated systematical uncertainty	0.003	0.003	0.005	0.005	0.003	0.003	0.005	0.005

Measuring period: June 1979

II.7.: Measurement results for the transfer-standards PTB-3 and OMH-1, measured at the NBS (Boulder, USA)

BIPM 75 - A5: VOLTAGE (1V) IN COAXIAL GUIDE SYSTEMS

AT 100 MHz, 250 MHz, 500 MHz, 1000 MHz

Pilot laboratory: PTB

(COMPARISON CYCLE II)

ROOM TEMPERATURE (°C)	:	= 20°
ROOM RELATIVE HUMIDITY (%)	:	= 40%
TEMPERATURE OF THE WATER-BATH FEEDING THE WATER-JACKETS OF THE STANDARDS	:	—
RELATIVE UNCERTAINTY OF THE FREQUENCY	:	—
VOLTAGE (V)	:	0.8 ≤ V ≤ 1.0

Designation of the standard	PTB - 3 Reg.No. 2.22 - 2125 - 392/156 Ser.No. 125				OMH - 1 Reg. No. 76001			
	100	250	500	1000	100	250	500	1000
Measuring frequency (MHz)	100	250	500	1000	100	250	500	1000
Number of measurements	8	8	8	8	8	8	8	8
Mean value of RF/DC difference	+ 0.0105	+ 0.0549	+ 0.1216	- 0.2022	+ 0.0037	+ 0.0235	+ 0.0135	+ 0.1031
Standard deviation s	0.000141	0.000076	0.000082	0.000177	0.000205	0.000156	0.000173	0.000233
Standard deviation of the mean $\frac{s}{\sqrt{n}}$	0.000050	0.000027	0.000029	0.000063	0.000072	0.000055	0.000061	0.000082
Random error $\delta = \frac{3s}{\sqrt{n}}$	0.000150	0.000081	0.000087	0.000188	0.000217	0.000166	0.000183	0.000247
Minimum measured value	+ 0.01041	+ 0.05474	+ 0.12152	- 0.20228	+ 0.003378	+ 0.023376	+ 0.013272	+ 0.10275
Maximum measured value	+ 0.01080	+ 0.05496	+ 0.12166	- 0.20193	+ 0.004047	+ 0.023808	+ 0.013736	+ 0.10349
Estimated systematical uncertainty	0.0075	0.010	0.010	0.010	0.0075	0.010	0.010	0.010

II-8 Measurement results for the transfer-standards PTB-3 and OMH-1 at the EQD (UK)

BIPM - 75 - A5

Pilot laboratory: PTB

VOLTAGE (1V) IN COAXIAL GUIDE SYSTEMS

AT 100 MHz, 250 MHz, 500 MHz, 1000 MHz

(COMPARISON CYCLE II)

AMBIENT TEMPERATURE ( °C )	: 23 ± 1
AMBIENT RELATIVE HUMIDITY ( % )	: 40 ± 10
RELATIVE UNCERTAINTY OF THE FREQUENCY ( % )	: ----
DC VOLTAGE ( V )	: 1 ± 0.005
THERMOCOUPLE OUTPUT LEVEL AT 1 V DC (mV)	: 7.5
CURRENT REVERSAL DIFFERENCE ( % )	: 0.032

Designation of the standard	PTB - 3 Reg.No. 2.22 - 2125 - 392/156 Ser.Nr. 125				OMH - 1 Reg.No. 76 00 1			
	100	250	500	1000	100	250	500	1000
Measuring frequency (MHz)	100	250	500	1000	100	250	500	1000
Number of measurements	12	12	12	12	12	12	12	12
Mean value of RF/DC difference	+ 0.01025 <sup>+) </sup>	+ 0.05160	+ 0.11337	- 0.20984	+ 0.00681	+ 0.0260	+ 0.0143	+ 0.1137
Standard deviation	0.00003	0.00003	0.00005	0.00003	0.000022	0.000018	0.000037	0.000031
Standard deviation of mean	0.000009	0.000008	0.000014	0.000009	0.000006	0.000005	0.000011	0.000009
Minimum measured value	+ 0.01020	+ 0.05155	+ 0.11326	- 0.20989	+ 0.00677	+ 0.02599	+ 0.01420	+ 0.11359
Maximum measured value	+ 0.01030	+ 0.05164	+ 0.11343	- 0.20980	+ 0.00684	+ 0.02605	+ 0.01431	+ 0.11370
Estimated systematic uncertainty	± 0.0025	± 0.007	± 0.007	± 0.008	± 0.0025	± 0.007	± 0.007	± 0.007

<sup>+)</sup>  For transfer-standard PTB the following approximated values for the RF-DC difference were obtained when the cylindrical insert was not fitted.

100 MHz	250 MHz	500 MHz	1000 MHz
+ 0.010	+ 0.051	+ 0.110	- 0.220

Measuring period: 14./15. February 1980

II.9. Measurement results for the  
transfer-standards PTB 3 and  
OMH 1 (2. re-measurement in the  
pilot-laboratory)

VOLTAGE ( 1V ) IN COAXIAL GUIDE SYSTEMS

Pilot laboratory: PTB

AT 100 MHz, 250 MHz, 500 MHz, 1000 MHz

( COMPARISON CYCLE II )

Room temperature (°C)	:	21 ± 1
Room relative humidity ( % )	:	50 ± 10
Temperature of the water-bath feeding the water jackets of the standards ( °C )	:	-
Relative uncertainty of the frequency	:	1.10 <sup>-4</sup>
Voltage ( V )	:	1.0 V

Designation of the standard	PTB - 3 Reg.No. 2.22-2125-392/156, Ser.No. 125				OMH - 1 Reg.No. 76001			
	100	250	500	1000	100	250	500	1000
Measuring frequency (MHz)	100	250	500	1000	100	250	500	1000
Number of measurements	6	6	6	6	6	6	6	6
Mean value of RF/DC difference	+ 0.0110	+ 0.0557	+ 0.1190	- 0.2092	+ 0.0072	+ 0.0287	+ 0.0186	+ 0.1157
Standard deviation	0.00009	0.00006	0.00019	0.0003	0.00004	0.0002	0.0002	0.0005
Standard deviation of the mean	0.00004	0.00003	0.00008	0.0001	0.00002	0.00007	0.00006	0.0002
Maximum measured value	0.01113	0.05579	0.11940	- 0.20858	+ 0.00720	+ 0.02900	+ 0.01887	+ 0.1162
Minimum measured value	0.01090	0.05564	0.11896	- 0.20938	+ 0.00711	+ 0.02854	+ 0.01845	+ 0.1152
Estimated system- atical uncertainty	0.003	0.003	0.005	0.005	0.003	0.003	0.005	0.005

Measuring period: July 1980

II. 10 Results for the measurement of the transfer standards PTB-3 and OMH-1 in NML (Australia)

VOLTAGE (1 V) IN COAXIAL GUIDE SYSTEMS  
at 100 MHz, 250 MHz, 500 MHz, 1000 MHz  
GT-RF 75 - A5  
(Comparison cycle II)

Pilot laboratory: PTB

ROOM RELATIVE TEMPERATURE (°C)	: 21.5 ± 0.5
ROOM RELATIVE HUMIDITY (%)	: 55 ± 5
TEMPERATURE OF THE WATER BATH FEEDING THE WATER JACKETS OF THE STANDARDS (°C)	: 21.5 ± 0.05
RELATIVE UNCERTAINTY OF THE FREQUENCY	: ± 1 · 10 <sup>-5</sup>
VOLTAGE (V)	: 0.99 ± 0.01

Designation of the standard	PTB - 3				OMH - 1			
	Reg.No. 2.22-2125-392/156 Ser.No. 125				Reg.No. 76001			
Measuring frequency (MHz)	100	250	500	1000	100	250	500	1000
Number of <u>sets</u> of measurements	4	3	4	4	4	5	3	8
Number of measurements for each set	60	60	60	40	60	40	60	40
Total number of measurements	240	180	240	160	240	200	180	320
Mean value of RF/DC difference	0.0122	0.0548	0.1134	- 0.22	0.0087	0.030	0.0185	0.1184
Standard deviation (sets combined)	0.000103	0.000027	0.000257	0.000194	0.000137	0.000387	0.000075	0.000224
Standard deviation of the mean (sets combined)	0.000007	0.000002	0.000015	0.000015	0.000009	0.000027	0.000006	0.000013
Minimum measured value	0.01210	0.05482	0.11317	- 0.22050	0.00859	0.02948	0.01843	0.11814
Maximum measured value	0.01238	0.05485	0.11370	- 0.22001	0.00891	0.03067	0.01859	0.11881
Estimated systematical uncertainty (99%)	± 0.0032	± 0.005	± 0.0083	± 0.0109	± 0.003	± 0.0044	± 0.0061	± 0.0096

Measuring period: February 1981, May-July 1981 (PTB-3)  
 February-April 1981, July 81 (OMH-1)

II.11 Measuring results for the  
transfer standards PTB-3  
and OMH-1, measured in PTB  
(last measurement)

VOLTAGE (1 V) IN COAXIAL GUIDE SYSTEMS

Pilot laboratory: PTB

AT

100 MHz, 250 MHz, 500 MHz and 1000 MHz

GT-RF 75 A-5

(Comparison cycle II)

ROOM TEMPERATURE (°C)	: 21 + 1
ROOM RELATIVE HUMIDITY (%)	: 50 + 10
TEMPERATURE OF THE WATER-BATH FEEDING THE WATER JACKETS OF THE STANDARDS (°C)	: ---
RELATIVE UNCERTAINTY OF THE FREQUENCY	: $\leq 1 \cdot 10^{-4}$
VOLTAGE (V)	: 1.00 + 0.01

Designation of the standard	PTB - 3 Reg.No. 2.22-2125/392/156, Ser.Nr. 125				OMH - 1 * Reg.No. 76001			
	100	250	500	1000	100	250	500	1000
Measuring frequency (MHz)	100	250	500	1000	100	250	500	1000
Number of measurements	6	6	6	6	6	6	6	6
Mean value of RF/DC difference	+ 0.01092	+ 0.05560	+ 0.11821	- 0.20896	+ 0.00709	+ 0.02921	+ 0.02334	+ 0.05839
Standard deviation	0.00008	0.00023	0.00016	0.00022	0.00003	0.00006	0.00007	0.00015
Standard deviation of mean	0.00003	0.00009	0.00006	0.00009	0.000012	0.00003	0.00003	0.00006
Maximum measured value	+ 0.01100	+ 0.05590	+ 0.11841	- 0.20874	+ 0.00711	+ 0.02932	+ 0.02312	+ 0.05855
Minimum measured value	+ 0.01080	+ 0.05540	+ 0.11806	- 0.20925	+ 0.00706	+ 0.02915	+ 0.02326	+ 0.05818
Estimated systematical uncertainty	0.003	0.003	0.005	0.005	0.003	0.003	0.005	0.005

\* The thermocouple of OMH-1 burnt out after the last measurement (II.10) in Australia.  
The results of II.11 refer to a new thermocouple installed by the pilot laboratory.  
These values will not be included into the evaluation of the international comparison.

Measuring period: March 1982