

INTI during the COVID pandemic

June 2020

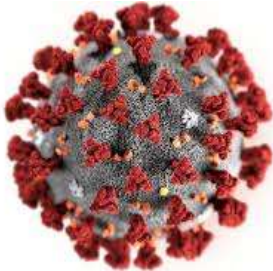
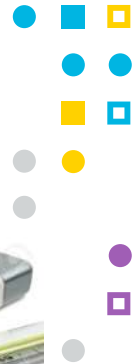

Closure of activities on March, 20.

Since then all the staff is doing home office.

Only Labs related to the health sector were in operation:

- 1. Body temperature**
- 2. UV**
- 3. Flow**
- 4. Ventilators**
- 5. Chemistry**
- 6. Textiles**

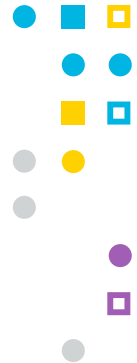

Human body temperature measurement

In Argentina, only contact thermometers are regulated for the measurement of human body temperature

Resolution 83/2012-SCI: Metrological and Technical Regulation for electric digital clinical thermometers with Maximum Temperature Measurement Device.

Resolution 28/2002 - S.C.D. y D.C: Annex to Metrological and Technical Regulation of Common Market Group –GMC- N° 17/2001 about mercury-in-glass clinical thermometers for human body temperature measurement.

**Initial verification of 400 samples of clinical thermometers –
50.000 units**

INTI San Luis
INTI Metrología Física



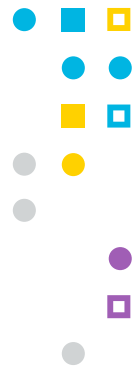

Human body temperature measurement

Recomendation and technical advice on cameras

Advice on measurement technologies, their reliability and the appropriate methods of implementation



1. NOTE to Ministry of Health: Suggestions for measuring body temperature - 1/4/2020
2. NOTE to the general public: Suggestions for measuring body temperature - 7/4/2020
3. Technical advice to the National Directorate of Migrations for the acquisition of thermographic cameras for fever detection and IR radiation thermometers for frontal use, for border control.

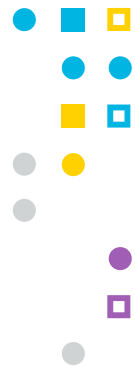

Human body temperature measurement

Test and Calibrations

Methodologies were specially developed to carry out the following tests since these are services in which the laboratory had no previous experience



1. Test of a prototype of radiation thermometer developed at the Institute of Biomedical Engineering - University of Buenos Aires. Evaluation of the indication of the radiation thermometer as a function of the size of the radiant source

2. IR radiation thermometer calibrations using Fluke 4180 Radiant Source

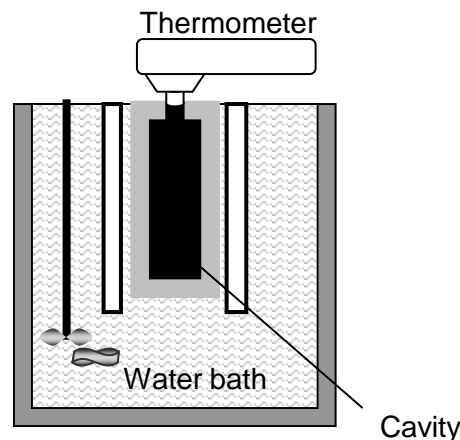

3. IR radiation thermometer: XXXXX Determination of correction in otic and frontal mode Reference: Submerged cavity in water bath Fluke 4180 Radiant source

4. IR radiation thermometer: XXXX Determination of correction in front mode Reference: Cavity submerged in a water bath

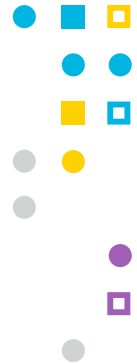

Instruments based on IR radiation have been widely used because they avoid contact, are fast and can be used for controls on large numbers of people.

Its use to measure body temperature in humans requires care and its reliability is questioned by experts from around the world. See CEM Spain recommendation

The few experiences that we recently carried out and the study of the existing bibliography on the subject highlights the need to develop in our laboratory the capabilities to carry out metrological controls that ensure the reliability of this type of thermometer for measuring body temperature.

Irradiance measurements in UVC equipments to inactivate coronavirus

The Radiometry and Photometry Laboratory performs irradiance measurements in the UV-C range using its dual-monochromator reference spectrum-radiometer, equipped with silicon detectors and photomultiplier.

These measurements allow estimating the emission times necessary for the inactivation of COVID-19.

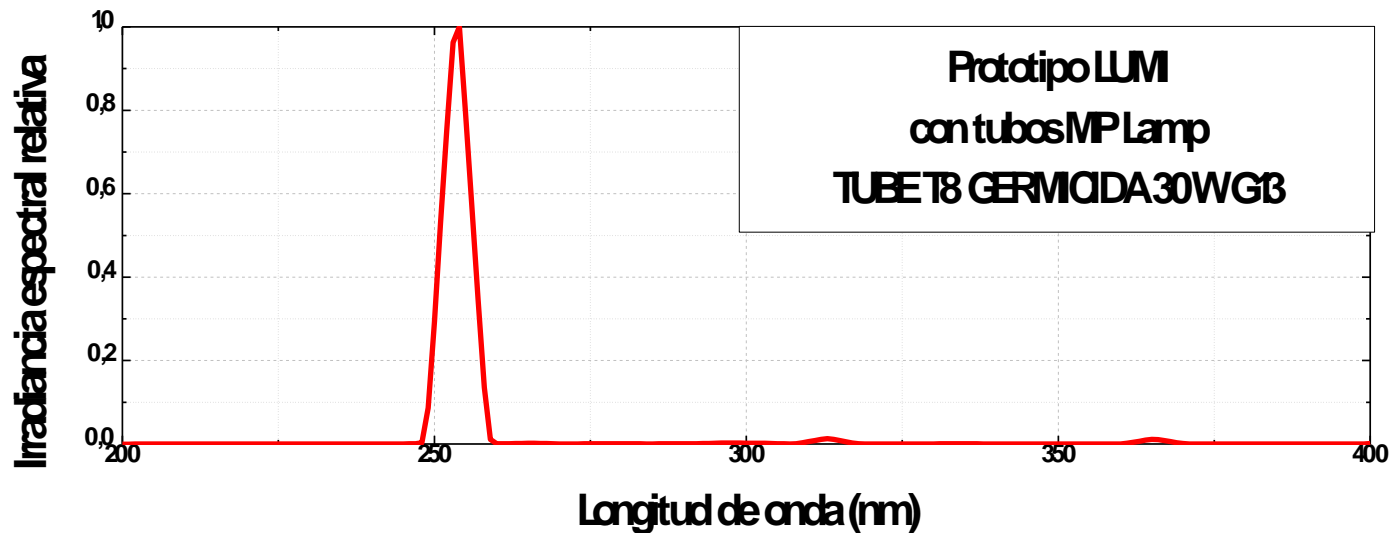

Spectrum emitted by UV-C equipment. The peak corresponds to the emission centered on a wavelength of 253.7nm corresponding to mercury.

Testing of UVC disinfection columns



UV-C XXX disinfection column prototype



UV-C YYYYY disinfection column prototype



Prototype machine supplied with a UV-C PL type lamp

Flow and Volumen



Project: Modify anesthesia respirators into emergency therapy respirators

Aim: To provide the health system with more resources in order to prevent its collapse facing a pandemic situation

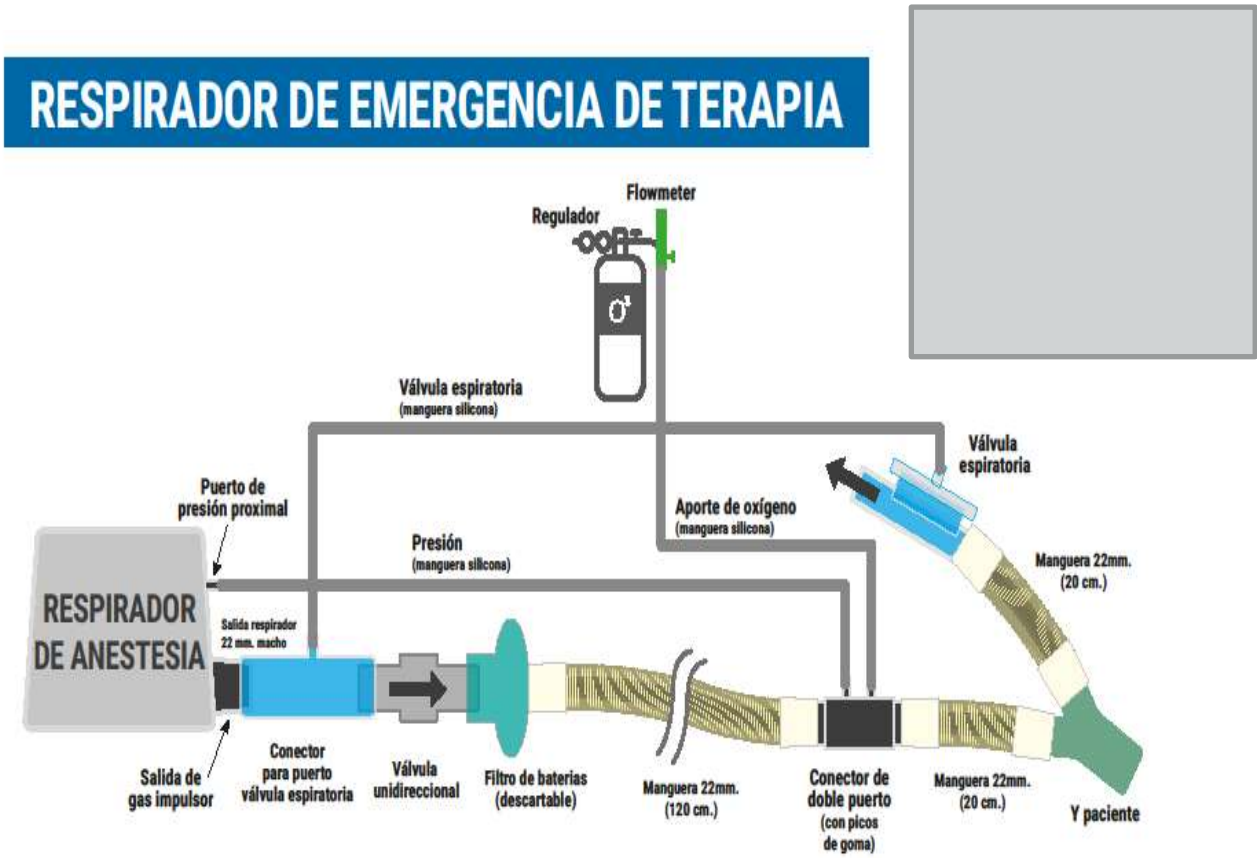

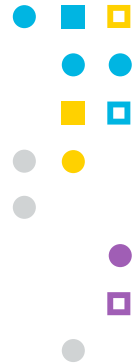

Aims: Technical assistance to the local industry in the development of inspiratory and expiratory valves to comply with the National standard and to be approved by the National Administration of Medicines, Food and Medical Technology (A.N.M.A.T.)

Tests: According to standard IRAM 4220-2-13:2019.

These tests require constant instantaneous flow rates and accuracy pressure measurement

Development of one of the tests at a flow rate of 20 ml / min for opening tests

Opening pressure $U = 0,1$ hPa

1. Fluid flow direction
2. Flow measurement device
3. Rigid container
4. Intake pressure
5. Valve to be tested

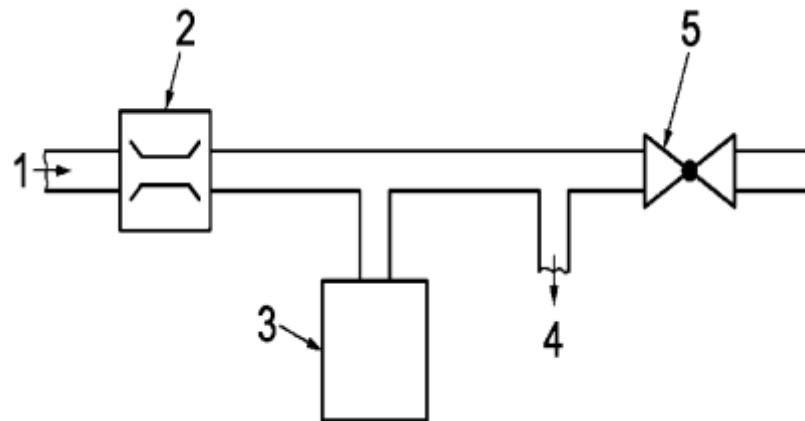

Installation scheme

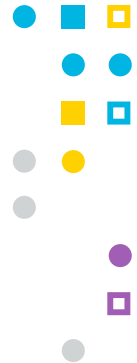

Standard valve operation at instantaneous flow rates tests: 20 to 60 ml / min -
5 to 60 l / min



Inspiratory valve



Expiratory valve

Standards used: time-based rotary piston volumetric counter to determine an average flow.

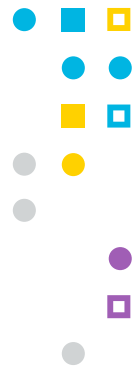

Low cost ventilator

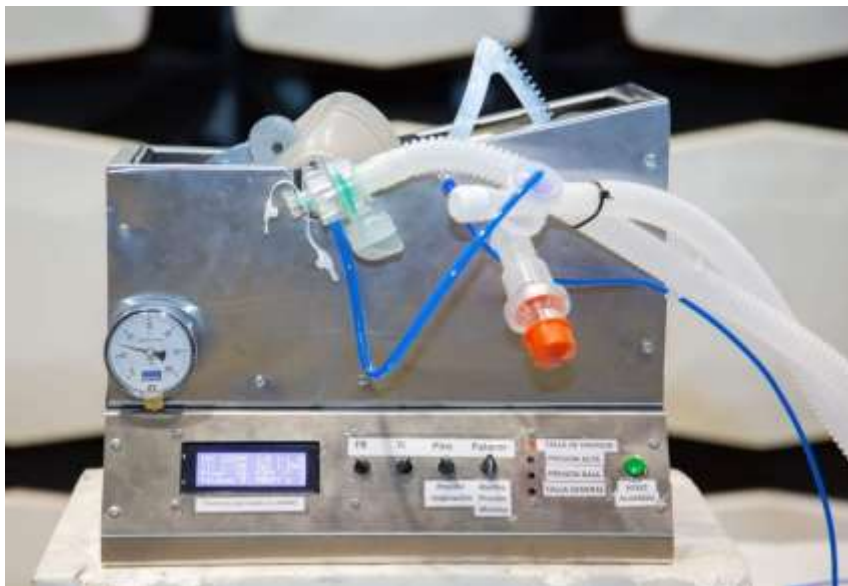

INTI leads a team with industrial SMEs and other public organizations to develop low cost ventilators to strengthen the capacities of the health system facing the COVID-19 pandemic

In addition, the institute is collaborating with more than 10 ventilator projects across the country and other initiatives related to the health emergency.

Low cost ventilator

The project is based on the automation of a manual ventilation bag - commonly known as AMBU (Airway Mask Bag Unit), a device that hospitals use as respiratory support in emergency situations.

It is a simple system that uses a motor to drive a mechanism that compresses the manual ventilation bag, in which the ventilatory parameters that are controlled are the respiratory rate, the inspiratory pressure, the inspiratory time and the positive pressure at the end of expiration.

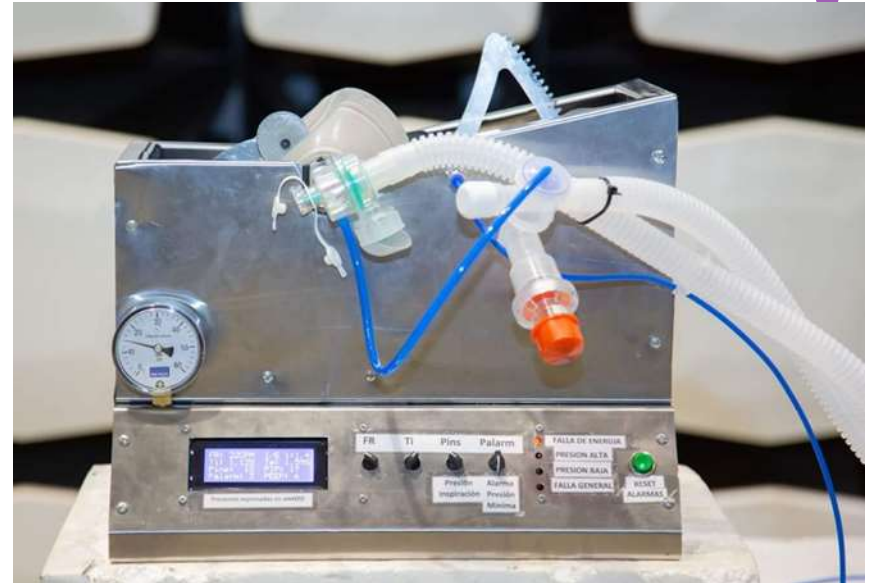

All elements in contact with the patient's gases are medical grade and allow the placement of HEPA filter systems between the tracheal tube and the device, so that the air exhaled by the patient is free of COVID-19.

R&D in Chemistry

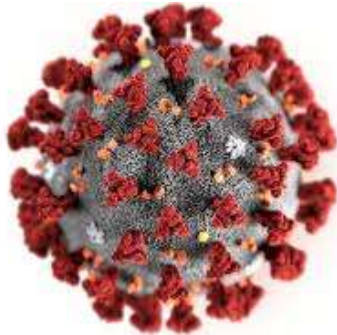

- **Technical support for health care products with virucidal activity**
- **Advise for the correct use of sanitizing products according to WHO, PAHO and ATA guidelines**
- **Development for hand sanitizer formulation with carbomer substitute**
- **Synthesis of Active Pharmaceutical Ingredients- Process Development**

Textiles

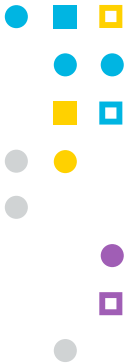

Presentation of 2 Projects to the Agency for the Promotion of Research, Technological Development and Innovation - MINCyT, both approved:

- “Sustainable solutions and developments for the certification of textiles and PPE (personal protection elements) to reduce the spread of COVID-19“
Textiles management
Financed amount: USD 100,000
- "Development of antiviral coatings for textiles for use in personal protection elements.
Nanomaterials Area Management, participation of Textiles.
Financed amount: USD 35,000

Textiles

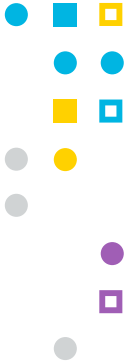

Technical assistance and tests on:

- Priority material for PPE of health personnel (chinstraps, caps, gowns)
- Material for social protection clothing
- Evaluation of products made by different companies in order to make medical clothing. Nationally manufactured cloths are evaluated to replace imported cloth known as Tyvek.

Permanent interaction with public organizations:

- ANMAT
- Ministry of Industry
- Ministry of Health of the Nation
- Provincial and municipal organizations
- Health establishments

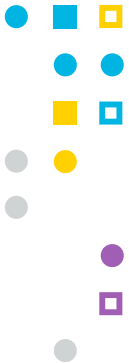

Textiles

Main Tests

- Tests on Surgical clothing and drapes (gowns) – Standard UNE-EN 13795-1:2020
 - Dry and wet microbial penetration
 - Microbial cleaning (Biotechnology)
 - Release of foreign matter (Textiles)
 - Liquid penetration (Textiles)
 - Dry and wet breaking strength (Textiles)
 - Dry and wet tensile strength (Textiles)

- Tests on surgical face masks – Standard UNE-EN 14683
 - Bacterial Filtration Efficiency: equipment required
 - Differential Pressure (Textiles. Tuning).
 - Splash Resistance Pressure (Textiles. Tuning)
 - Microbial Cleanliness (Biotechnology)
 - Marking, labeling and packaging (Textiles/Packaging)

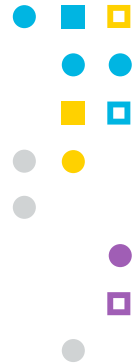

Textiles

Available publications at <https://www.inti.gob.ar/publicaciones>

- Reusable Hygienic Masks. Recommendations for Industrial Manufacturing
- Hygienic clothing. Recommendations on Good Manufacturing Practices
- Guidelines for the running of garment stores and the handling of garments

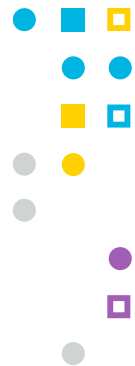

Thank you!